

SOLE BOARD

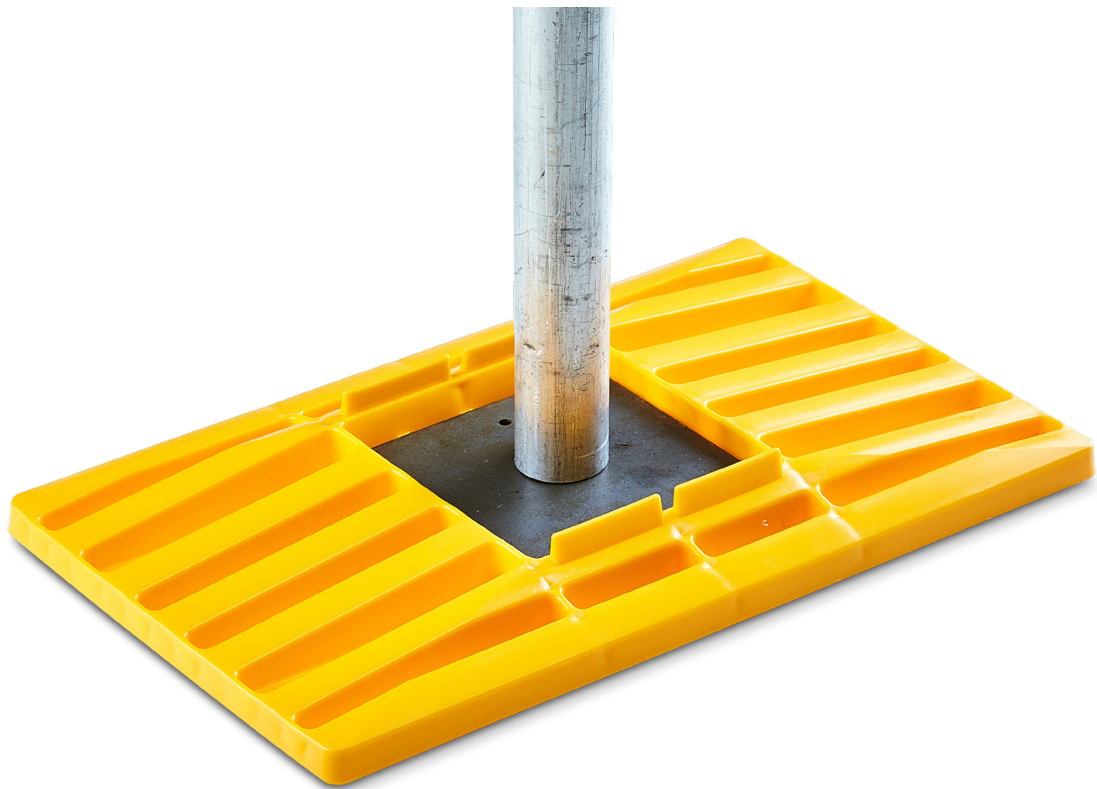



CONTENTS

PAGE

3	Features
4	Dimensions and weights
5	Load deflection data
6	Inspection and maintenance
7	Installation and safe handling
8	Recyclability
9	Associated products
10	Contact information





FEATURES

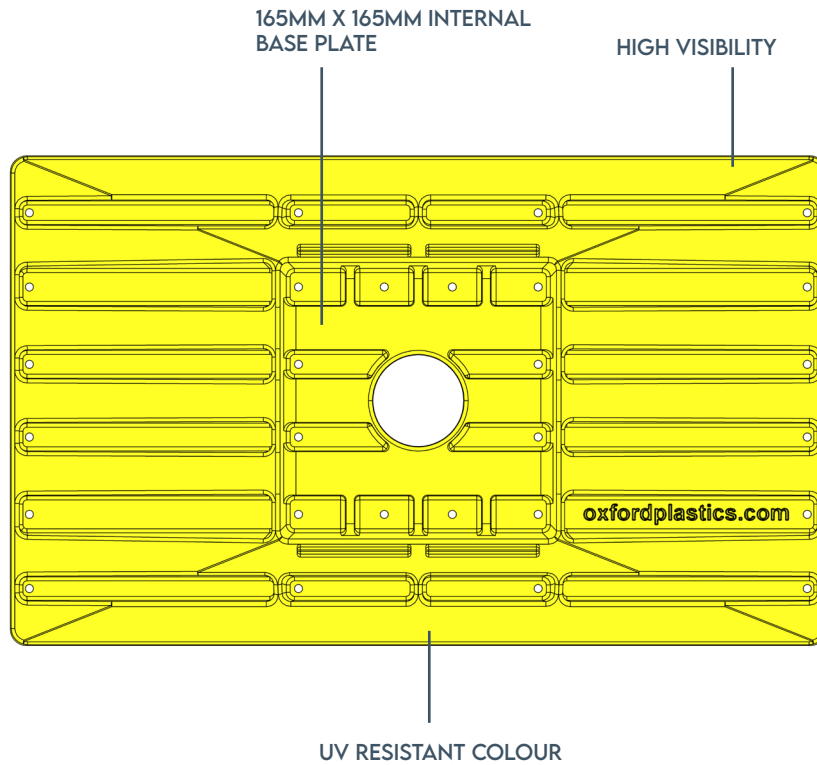

ROBUST

Distributes the load of scaffolding.

Gives stability and safety for scaffolding on soft ground.

Made in HDPE that has an operating temperature of +50°C / 120°F to -30°C / -20°F.

Non-metal construction reduces theft.

Non- conductive.

SAFE & EASY TO USE

Suitable for 15T loads on flat, level ground.

Large 1.5m² footprint.

Quick to install.

No need for bolts.

Replaces timber scaffolding board base plates.

Low profile design minimises trip hazards to pedestrians and workers.



DIMENSIONS AND WEIGHTS

SOLE BOARD 1.7kg / 4lbs

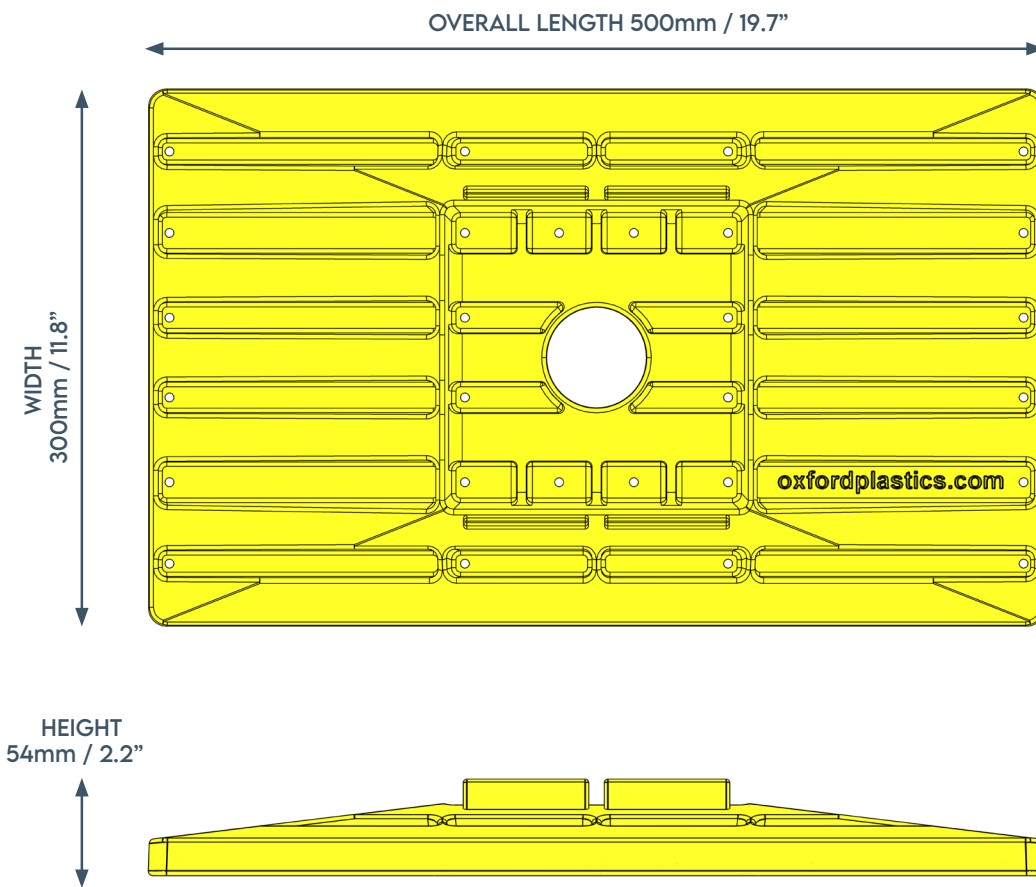

Part Name

Sole Board

Product Code

O630

TESTING



PRODUCT RATING

The Sole Board is designed for reliability, safety and peace of mind. Unlike timber scaffold stands, the Sole Board will give a consistent load bearing strength use after use. Due to the organic material of timber boards, they will disintegrate and rot over time which leads to an inconsistent and highly variable load bearing capacity.

The Sole Board is designed to take a 15t load on an even and firm ground surface. The product is made from tough HDPE with a compressive strength of 15-28MPa.

INSPECTION AND MAINTENANCE

Care for the product by following the below guidance:

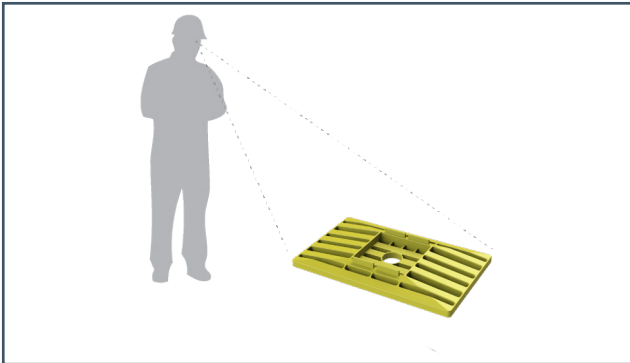

Inspect each product for signs of damage, between every installation.



Clean product between every installation to remove debris.

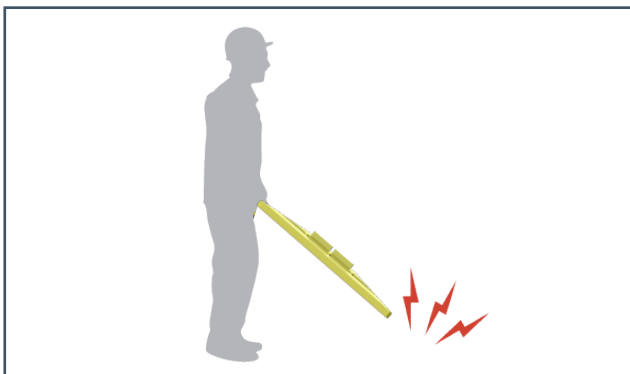

Do not drop the product.
Do not lift or move with machinery.

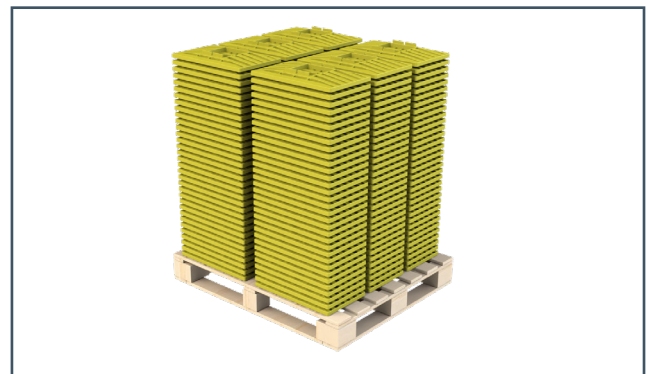

Stack 200 Sole Boards onto a pallet for storage and transportation.

SIGNS OF DAMAGE

Cracks in the yellow section indicate it has been damaged through improper use.

The product should lay flat on the ground depending on the ground conditions. A visibly bent product also indicates it has been damaged through improper use.

These products need to be disposed of.

INSTALLATION AND SAFE HANDLING

Prior to installing the Sole Board:

1. Complete a Site Specific Risk Assessment at the start of the project.
2. Inspect Sole Board for damage – do not use damaged boards.



Assess ground condition to ensure it's suitable for scaffolding boards.

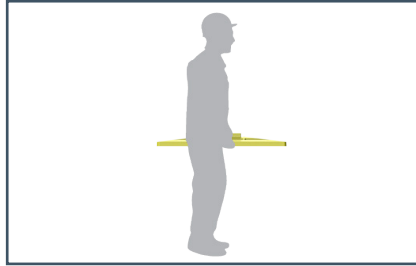

One person lift.



Position Sole Board on the ground.

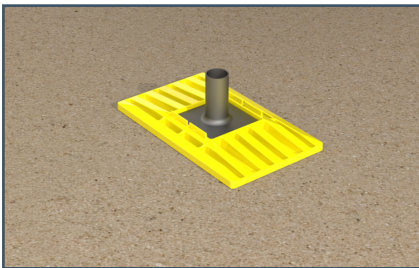

Place base plate into the Sole Board's 165mm x 165mm holder.

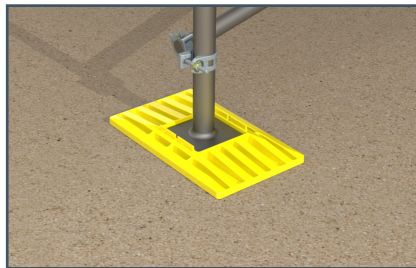

Place scaffolding pole onto the base plate.

In circumstances where the terrain is uneven the Sole Board can be used with the EnduraMat to help spread the load:

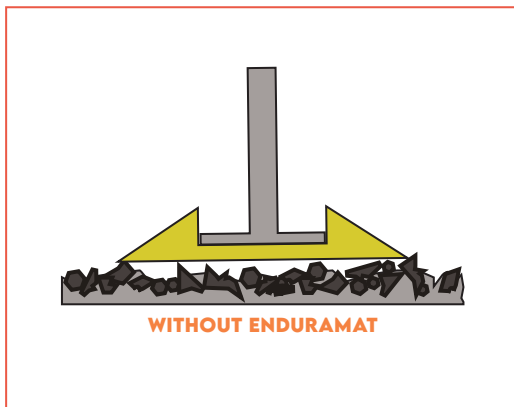

Ideally ground should be flat beneath the Sole Board to safely distribute load.

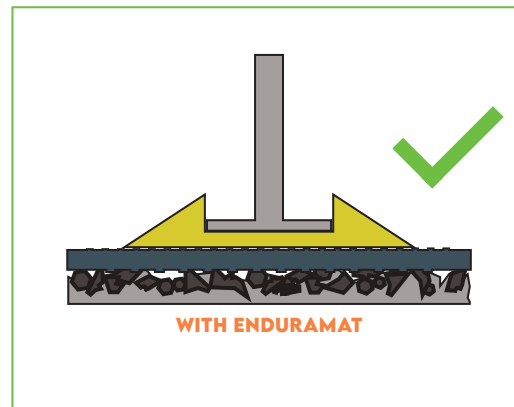

EnduraMat safely spreads load when ground is uneven.

RECYCLABILITY

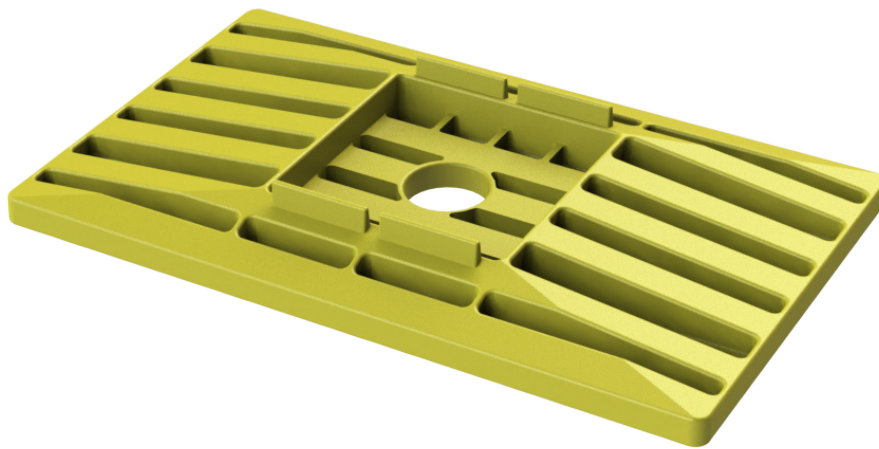

MATERIALS

Sole Board is made from HDPE and is fully recyclable.

Contact Oxford Plastics for returning end of life products.



ASSOCIATED PRODUCTS

When setting up a street works site, other Oxford Plastics solutions can be used to ensure compliance is achieved. Browse our Chapter 8 solutions; including advanced barrier systems, trench covers, road plates, wheelchair ramps and street works signs.



ADVANCED BARRIER SYSTEMS



PORTABLE GATE BARRIERS



STREET WORKS SIGNS



WHEELCHAIR RAMPS



TRENCH COVERS

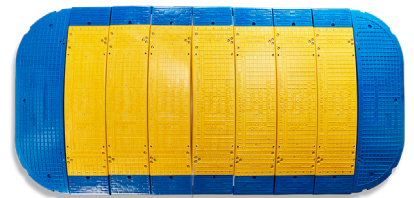

ROAD PLATES



CONTACT INFORMATION

UK & R.O.W

Oxford Plastic Systems Ltd
Unit T2, Enstone Business Park
Enstone,
Chipping Norton
Oxfordshire
OX7 4NP
United Kingdom

sales@oxfordplastics.com
Tel: +44(0)1608 678888

USA

Oxford Plastic Systems LLC
1011 Centre Rd,
Suite 312,
Wilmington
DE
19805
USA

info@oxfordplasticsusa.com
1-800-567-9182

