

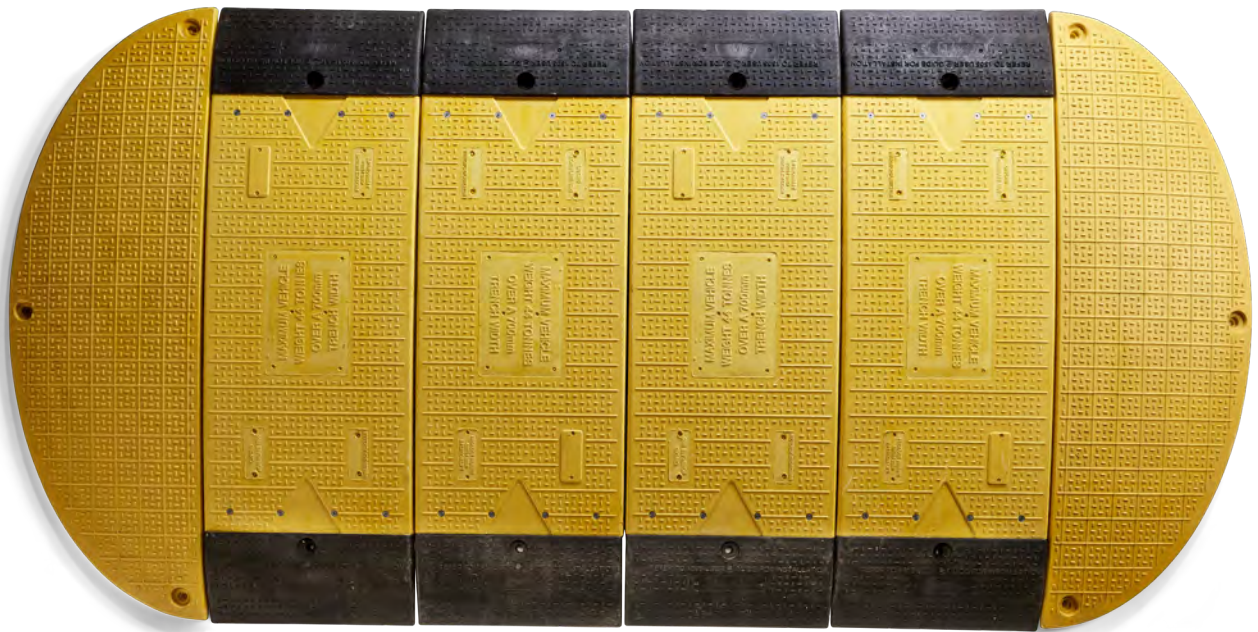

LOWPRO 15/05 ROAD PLATE





CONTENTS

PAGE	
3	Features
4	Dimensions and weights
5	Material composition and product life
6	Load deflection data
7	Maximum axle weights
8	Slip resistance
9-10	Inspection and maintenance
11-12	Replacement parts and tracing
13	Installation and safe handling
14	Overlap and soil conditions
15	Unattended sites
16	Safe speeds and clearance heights
17	Sustainability
18	Associated products
19	Trench cover guide
20	Code compliance
21	History of use
22	Composite Road Plate and Trench Cover sales
23	Contact information
24	Appendix A - USA Engineering approval tabulated data



FEATURES

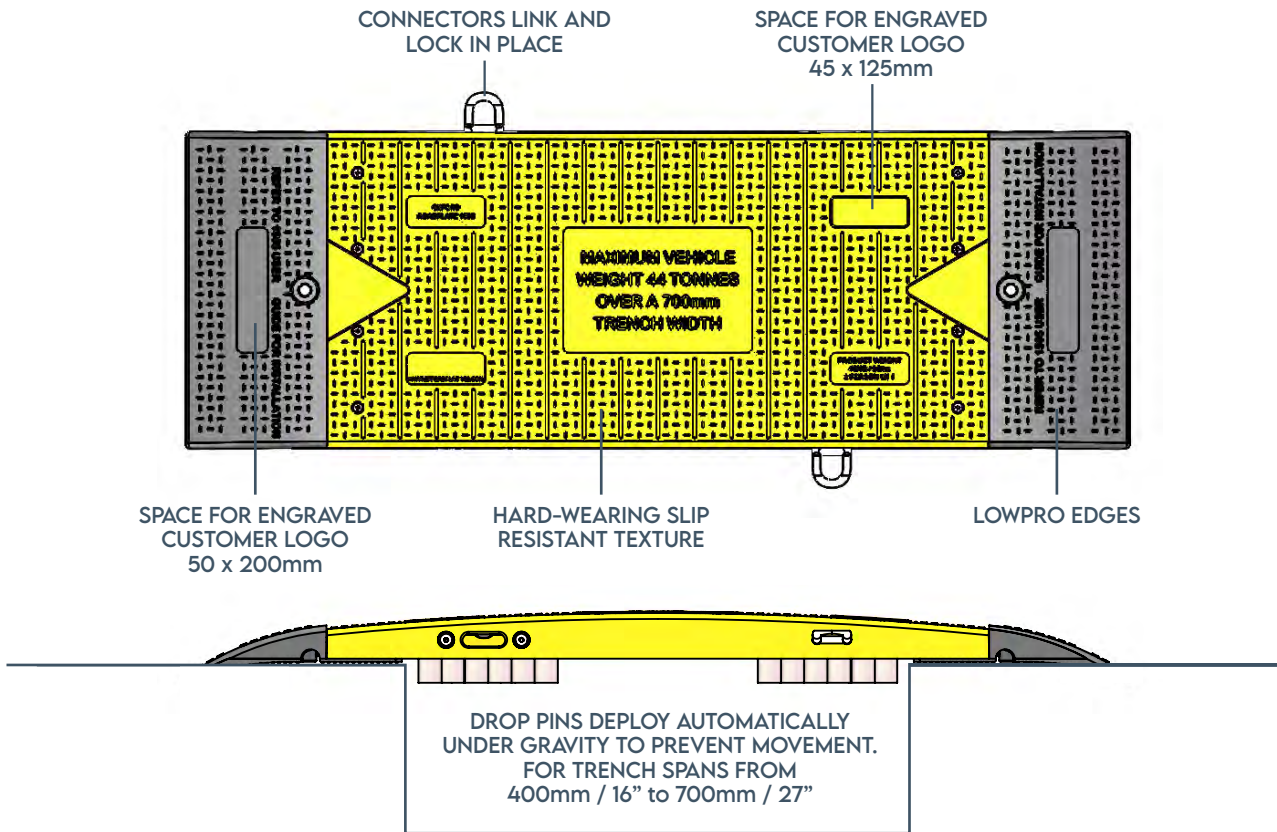

ROBUST AND SAFE

Advanced composite technology construction, robust and durable.

Integral slip resistant texture.

Inclined rubberised LowPro Edges prevent damage to road and reduce impact on vehicles. No need to 'cold patch'.

Proven to work in ambient temperatures of +50°C / 120°F to -30°C / -20°F. LowPro edges are more susceptible to damage in freezing temperatures.

QUICK INSTALLATION

Can be manually handled without the need for heavy lifting equipment.

Quick to Install, with In-built linking and locking system, no need to bolt all Road Plate sections to the ground.

Drop Pins are automatically deployed underneath to prevent movement on trenches, without the need to bolt every unit.

EXTRAS

Use Road Plate End Pieces to create a ramp at both ends.

Can be customised with logo, MOQs apply.

Spare parts are available to extend the life of your LowPro.

Non-metal construction reduces theft.



DIMENSIONS AND WEIGHTS

LOWPRO 15/05 ROAD PLATE - INNER PIECE 42kg / 93lb

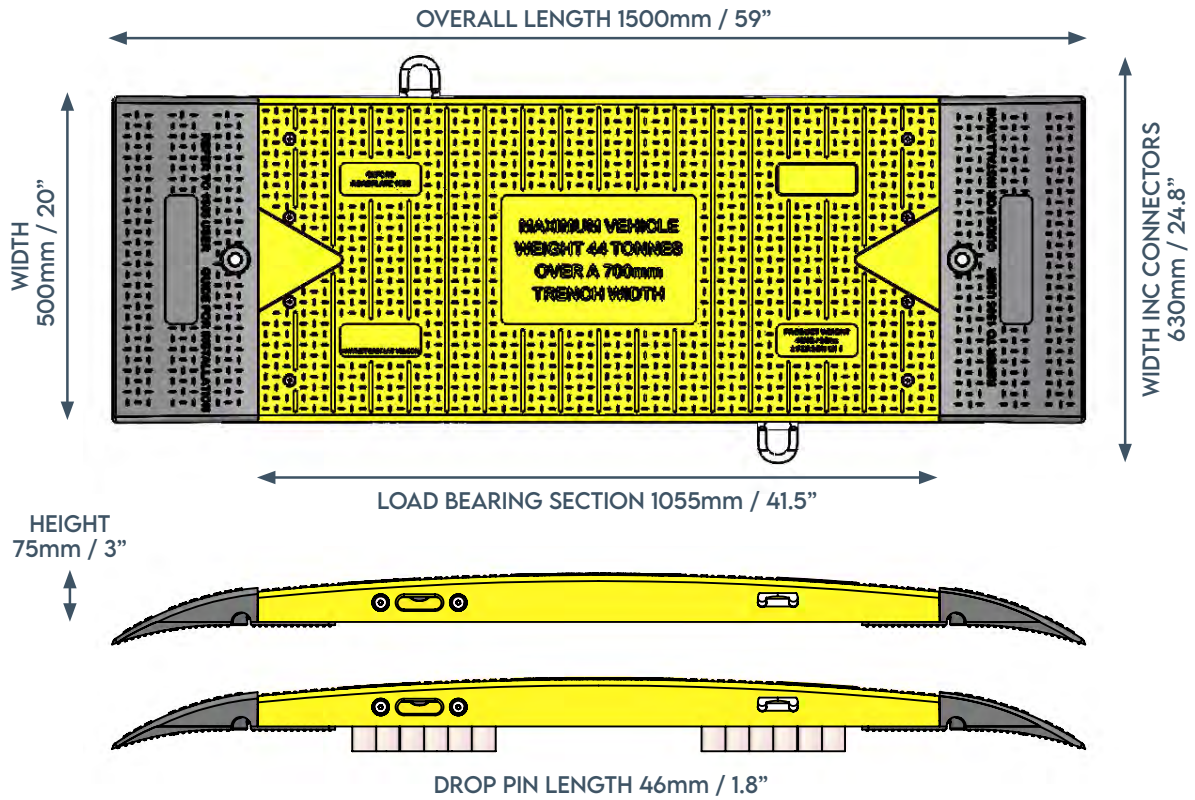

LOWPRO 15/05 ROAD PLATE - END PIECE 23kg / 51lb

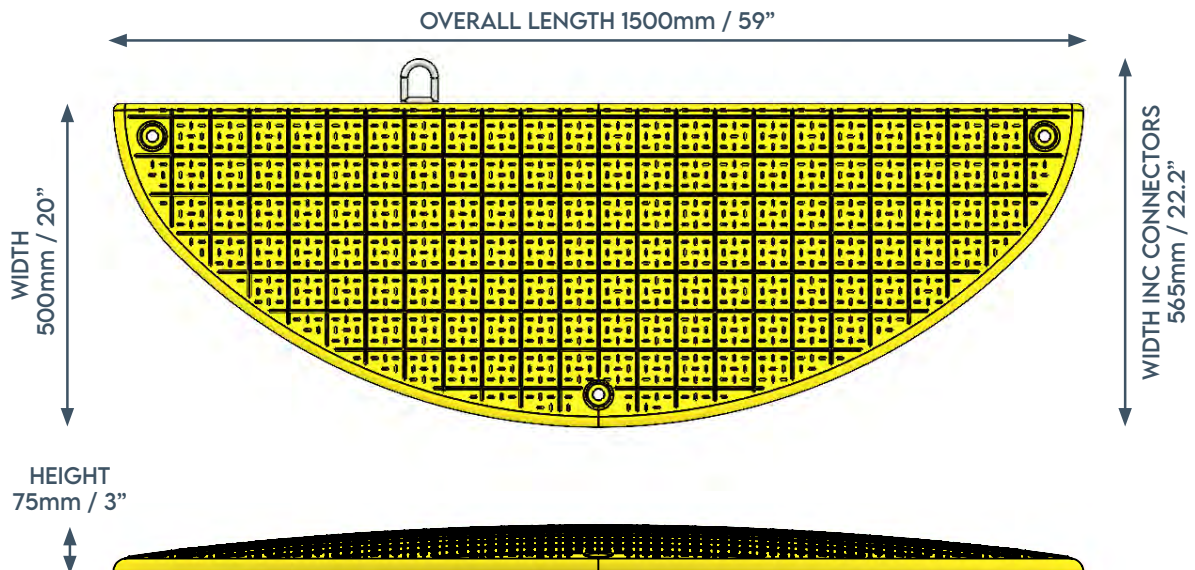



MATERIAL COMPOSITION AND PRODUCT LIFE

All elements use materials that if maintained correctly will not structurally degrade in UV light, in the presence of water or salts, and are stable in ambient temperatures from +50°C / 120°F to -30°C / -20°F. LowPro Edges are more susceptible to damage in freezing temperatures.

Batches are regularly load tested in the Oxford Plastics test facility as part of the quality control process.

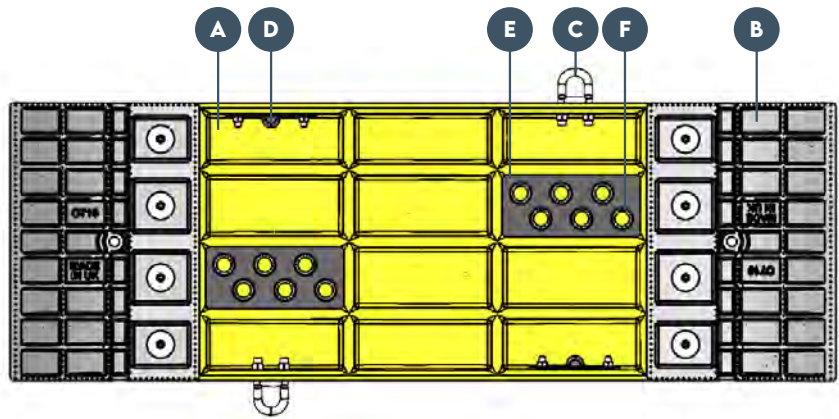

INNER PIECE	Part Name	Material
A	Main Body	Glass fibre reinforced polyester resin sheet moulding compound + Mild Steel encapsulated rebar grid
B	LowPro Edge	50% Queo Elastomer, 50% LDPE
C	Male Connector	Galvanised mild steel
D	Female Connector Plate	PP/PE
E	Drop Pin Tray	PP/PE
F	Drop Pins	Stainless Steel

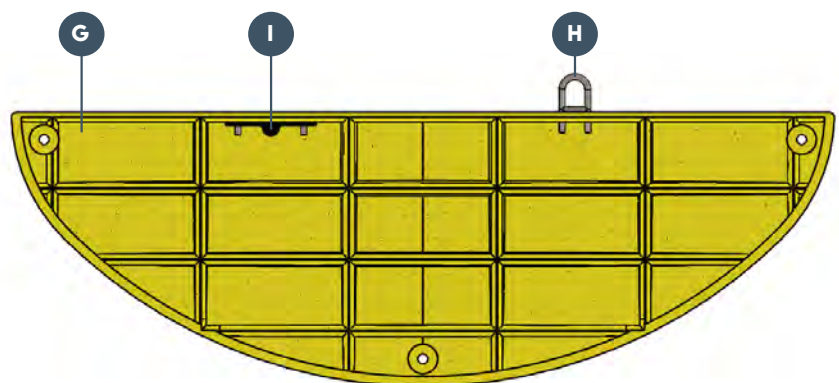

END PIECE	Part Name	Material
G	Main Body	Glass fibre reinforced polyester resin sheet moulding compound + Mild Steel encapsulated rebar grid
H	Male Connector	Galvanised mild steel
I	Female Connector Plate	PP/PE





LOAD DEFLECTION DATA

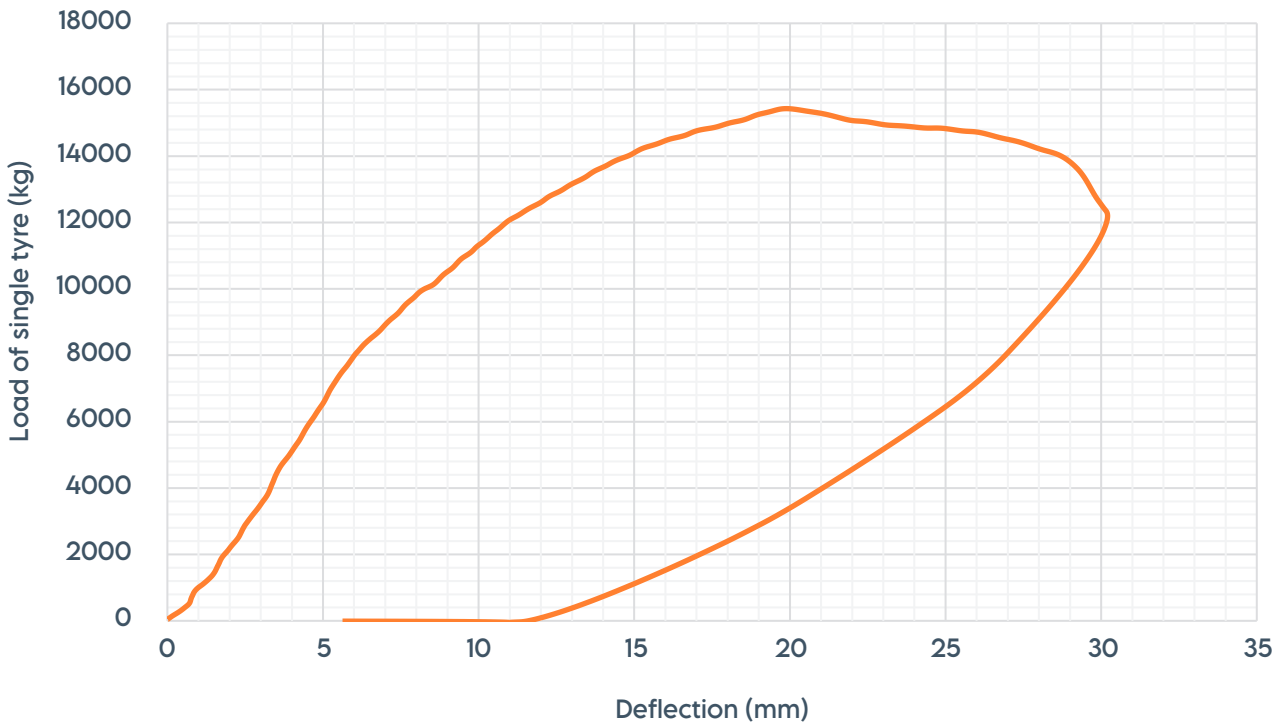

Deflection at 6000kg / 13,228lb

4.6mm / 0.18"

Ultimate load at failure

15,400kg / 33,951lb

Destructive testing has been carried out on the product to simulate deflection under the working load, and ultimate failure.

The testing is carried out by trained staff at Oxford Plastics' specialist testing facility.

Tab Data can be found in Appendix A.

Complies with HAUC 2018/01 Advice Note.

PRODUCT RATING

The product is rated for use over spans of maximum 700mm / 27" by vehicles with a GVW of up to

44t / 97,000lb

TEST SPECIFICATION

Span
700mm / 27"

Load Footprint
250mm / 9.8" diameter pad with rubber base to simulate single tyre.

Load Location
Centre of product.





MAXIMUM AXLE WEIGHTS

TERRITORY	Max single axle weight	Max single tyre weight
EU	11.0t	5.50t
Australia	8.2t	4.1t
New Zealand	10.0t	5.0t
Japan	7.7t	3.85t
Canada	7.3t	3.65t
USA	32,000lb	16,000lb

For more detailed data on:

Multiple axle loads,
Axle loads for different vehicles types,
Or territories not listed,
please consult and confirm with your
relevant transit authority.





SLIP RESISTANCE

Slip resistance testing has been carried out by an independent test house, in line with the requirements of UK HSE 2012 document 'Testing the slip resistance of flooring'.

Testing was carried out in 2 directions in wet conditions, using a skid resistance tester using a CEN slider and 4'S' slider.



CLASSIFICATIONS

High Slip Potential
0-24

Moderate Slip Potential
25-35

Low Slip Potential
36+

CEN SLIDER TEST RESULTS - WET

	Median Result	Classification
Parallel to traffic	48	LOW SLIP POTENTIAL
Perpendicular to traffic	41	LOW SLIP POTENTIAL

4'S' SLIDER TEST RESULTS - WET

Parallel to traffic	61	LOW SLIP POTENTIAL
Perpendicular to traffic	55	LOW SLIP POTENTIAL





INSPECTION AND MAINTENANCE

Products should be inspected and cleaned between every installation as follows.

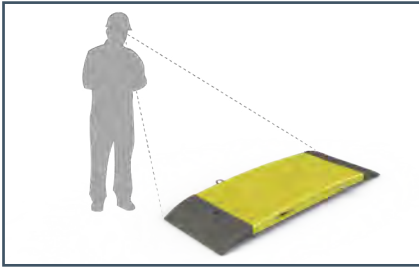

Inspect each product for signs of damage. See next page for signs of damage.



Ensure all drop pins are moving freely and drop pin trays are secure before use.

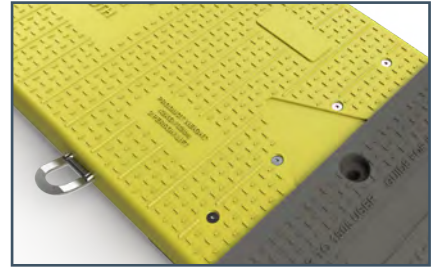

Ensure bolts on top surface are tight.



Ensure bolts on underside are tight.



Clean product to remove debris, to maintain slip resistance properties.



Stack 20 LowPro 15/05 Inners or Ends onto a pallet for storage and transportation.

Care for the product by following the below guidance:



Do not drag the product.



Do not lift the product as shown.

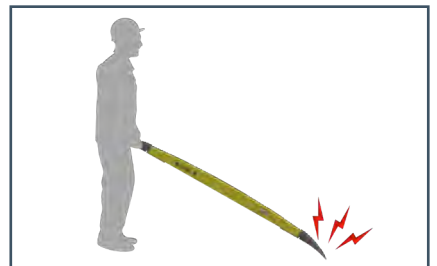

Do not drop the product.





INSPECTION AND MAINTENANCE

The images below show the signs to check for during inspection. 23/05 Road Plate shown as example.

Cracks or a bent product indicate it has been damaged through improper use. These products need to be disposed of.



Crack along rib

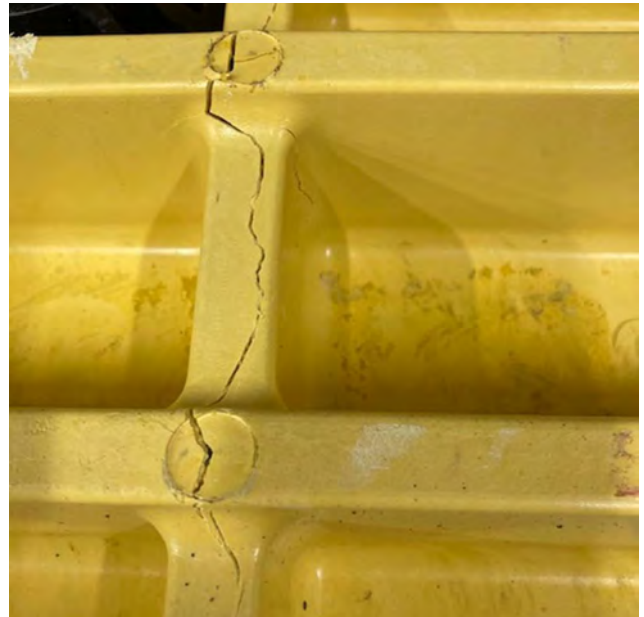

Close up of crack



The underside of the yellow section of the product is visibly bent. It should be flat.





REPLACEMENT PARTS AND TRACING

Parts are bolted together, enabling elements to be replaced easily in the unlikely event of damage.

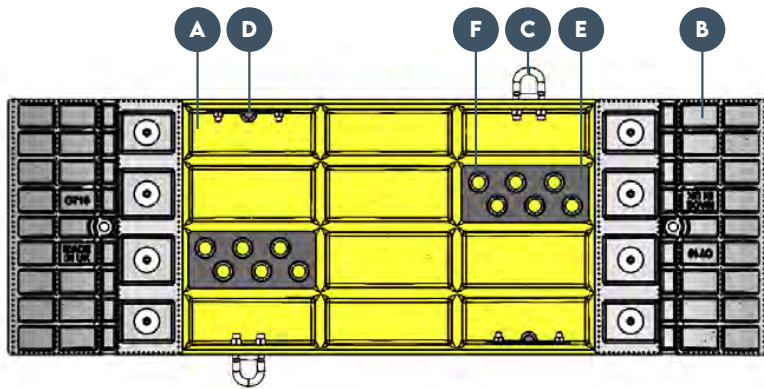

TRACING

Products have a waterproof label with a unique bar code and ID number, enabling tracing to the batch and date of manufacture.

INNER PIECE	Part Name	Product Code
A	Main Body	O830
B	LowPro Edge	O710
C	Male Connector	O703
D	Female Connector Plate	O808
E	Drop Pin Tray	O807
F	Drop Pins	O831, O832, O833

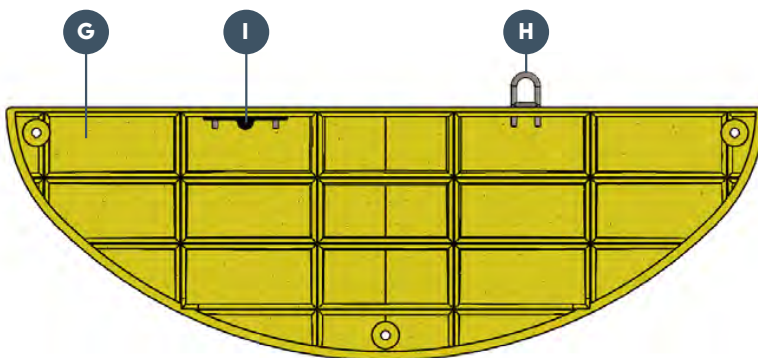

END PIECE	Part Name	Product Code
G	Main Body	O814
H	Male Connector	O703
I	Female Connector Plate	O808





REPLACEMENT PARTS AND TRACING

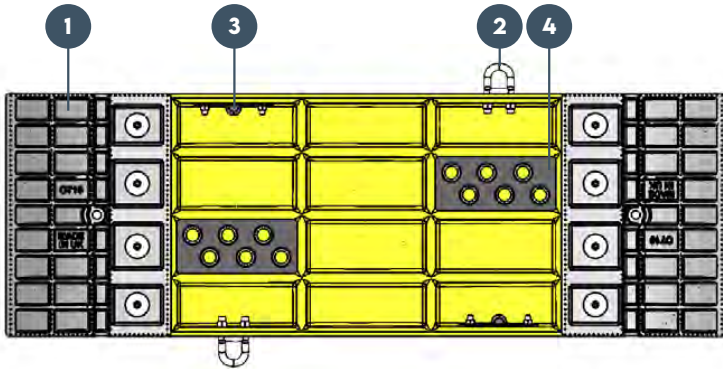

All fixings
Stainless Steel

	Fixings for	Metric	Imperial
1	LowPro Edge	EIGHT M8 CSNK MACHINE SCREW x 40 LNG EIGHT M8 WASHERS x 50 OD EIGHT M8 LOCK NUTS	EIGHT 5/16" CSNK MACHINE SCREW X 1 1/2" LNG EIGHT 5/16" WASHERS x 2" OD EIGHT 5/16" LOCK NUTS
2	Male Connector	FOUR M14 LOCK NUTS FOUR M14 WASHERS x 40 OD	FOUR 9/16" LOCK NUTS FOUR 9/16" WASHERS x 1 1/2" OD
3	Female Connector Plate	FOUR M10 CSNK SOC HD MACHINE SCREW x 40 LNG FOUR M10 LOCK NUTS	FOUR 3/8" CSNK SOC HD MACHINE SCREW x 1 1/2" LNG FOUR 5/16" LOCK NUTS
4	Drop Pin Tray	FOUR M5.5 HEX WASHER HEAD SELF-DRILLING SCREW x 70 LNG WITH 16OD BONDED WASHER	FOUR NO. 12 HEX WASHER HEAD SELF-DRILLING SCREW x 2 3/4" LNG WITH 16OD BONDED WASHER

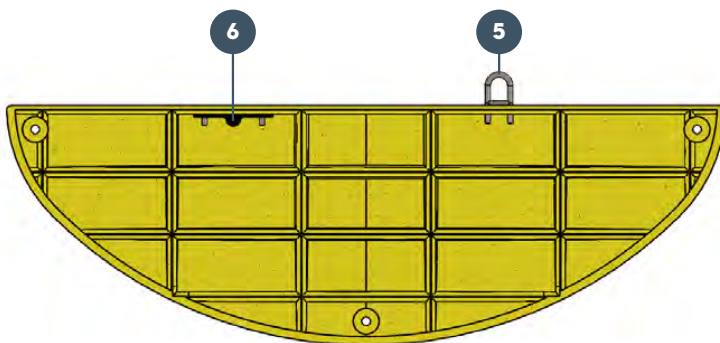

	Fixings for	Metric	Imperial
5	Male Connector	FOUR M14 LOCK NUTS FOUR M14 WASHERS x 40 OD	FOUR 9/16" LOCK NUTS FOUR 9/16" WASHERS x 1 1/2" OD
6	Female Connector Plate	FOUR M10 CSNK SOC HD MACHINE SCREW x 40 LNG FOUR M10 LOCK NUTS	FOUR 3/8" CSNK SOC HD MACHINE SCREW x 1 1/2" LNG FOUR 5/16" LOCK NUTS





INSTALLATION AND SAFE HANDLING

Follow the process below for safe and effective installations.

Risk assessments should be carried out to ensure the usage is suitable for the scenario.

In the USA, Road Plate installations must conform with Departments of Transport requirements in the local city. The minimum overlap can be as much as 15”.

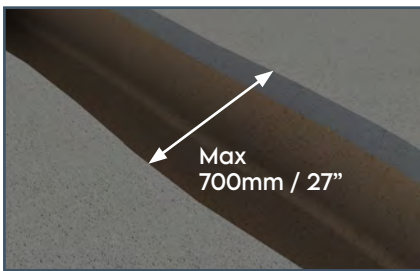

Ensure trench width less than 700mm / 27”. Assess trench stability prior to install.

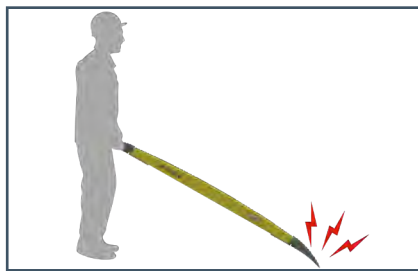

Two person lift at all times.

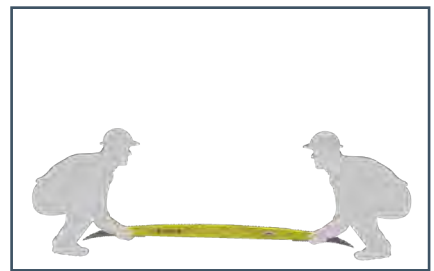

Bend at the knees in line with best practice.

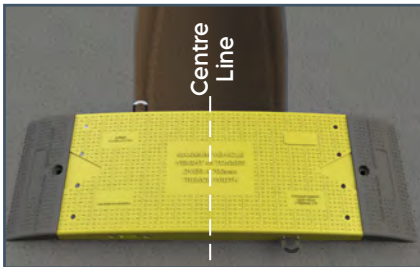

Position the first Inner Piece, using the centreline as a guide.

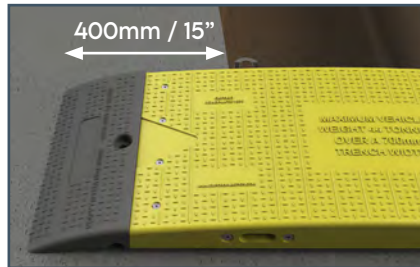

Check there is a minimum overlap of 400mm / 15”. Do this for every piece.



Move the next piece so that the connectors fit into the slots. When engaged, gently lower the piece.



Repeat until the entire trench is covered with Inner Pieces.

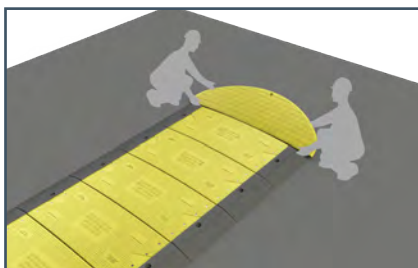

If required - Connect the End Piece.



The End Piece is not load bearing and must be entirely on solid ground.

Road Plates are designed for vehicles to travel across in a straight line. In situations where traffic will be turning on the plates, plates should be securely bolted down.





OVERLAP AND SOIL CONDITIONS

Ensure the product is centred on the trench, with a minimum overlap as shown below.

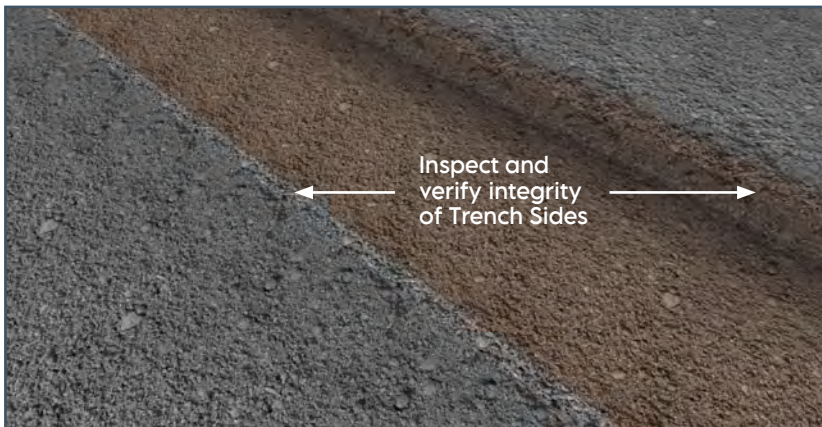
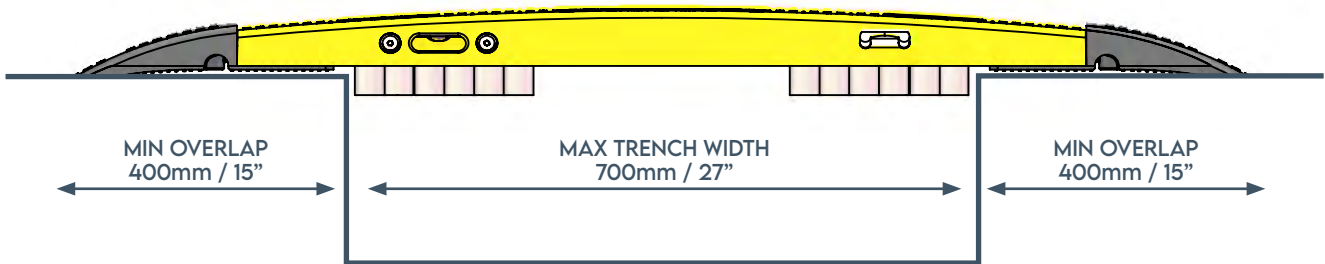

SOIL CONDITIONS

The soil or other substrates at the trench edges must be capable of supporting the maximum weight of vehicle for the particular install.

Risk assessments must be carried out prior to installation.





UNATTENDED SITES

When a site is unattended it is recommended that the outer sections are bolted securely to the road surface through the hole in the LowPro Edges.

An M16 x 150mm / 5/8" x 6' Masonry Anchor Bolt is typically used.

The installers must ensure the fixing used is suitable for the substrate conditions.

Risk assessments must be carried out prior to installation.

This set-up is also recommended at installations where traffic speeds exceed 30 mph / 48kph.

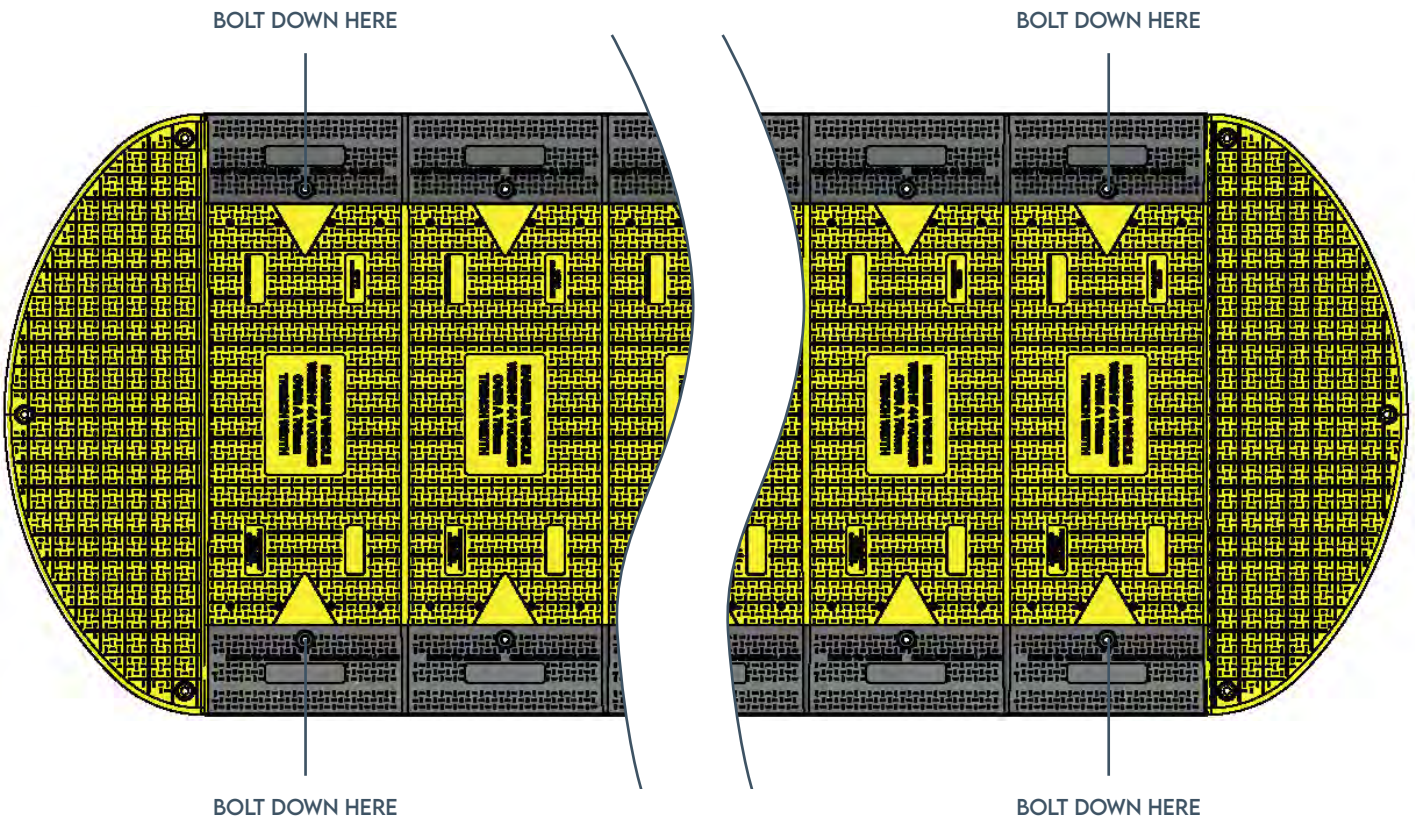
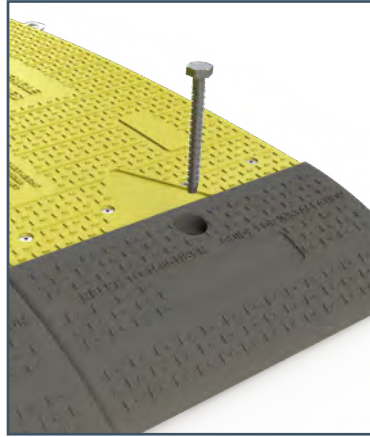



SAFE SPEEDS AND CLEARANCE HEIGHT

CLEARANCE HEIGHT
75mm / 3"

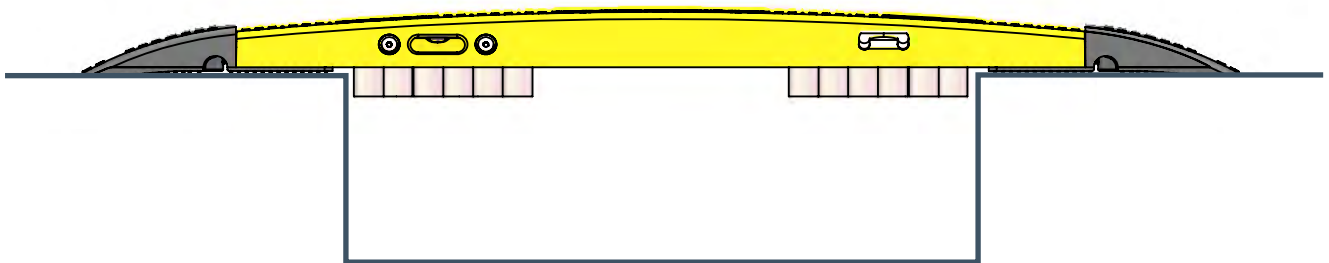

SAFE SPEEDS

The product is designed for use in urban areas, for a maximum carriageway speed of

30mph / 48kph

Where traffic speeds exceed 30 mph / 48kph it is recommended to additionally bolt as per recommendations on the Unattended Sites page.





SUSTAINABILITY

Oxford Plastics are dedicated to sustainability. We build the circular economy into our products by designing them to be easy to use, long-lasting, repairable and recyclable.

The LowPro Road Plates, a direct replacement for steel plates are a much more sustainable solution when compared.



LowPro Road Plates reduce up to 78% of CO2e compared with heavy steel road plates*.

*Please refer to Oxford Plastics Carbon Footprint & Product Report for more information





ASSOCIATED PRODUCTS

When setting up a street works site, other Oxford Plastics solutions can be used to ensure compliance is achieved. Browse our Chapter 8 solutions; including advanced barrier systems, trench covers, road plates, wheelchair ramps and street works signs.



**ADVANCED
BARRIER SYSTEMS**



**PORTABLE
GATE BARRIERS**



**STREET WORKS
SIGNS**



**WHEELCHAIR
RAMPS**



**TRENCH
COVERS**



**ROAD
PLATES**

















TRENCH COVER GUIDE

COMPOSITE TRENCH COVERS CAN BE INSTALLED IN THE FOLLOWING SCENARIOS.

- ▶ A Site Safety Risk Assessment must be carried out before installation, only install on compacted surfaces such as concrete or asphalt. Always place the trench cover centrally over the excavation.
- ▶ In some instances, road plates and trench covers must be bolted for safety, refer to the installation guide for more details.
- ▶ Trench covers have a maximum width allowance.
- ▶ Trench covers can be linked together to safely cover any length of excavation.
- ▶ The LowPro range is HAUC Compliant.
- ▶ LowPro 15/05 and LowPro 23/05 are HS20-44 load rated.
- ▶ Trench covers must be installed centrally over the trench.

MAXIMUM TRENCH WIDTH	WHAT TYPE OF TRAFFIC WILL CROSS THE TRENCH?		
	FOOTWAY 400KG / 880LBS	DRIVEWAY 3.5T / 7715LBS VEHICLE	ROADWAY 44T / 97000LBS VEHICLE
100MM 4"	 LowPro 100	 LowPro 100	 LowPro 15/05
700MM 2FT	 LowPro 12/8  LowPro 11/11	 LowPro 15/10	 LowPro 15/05
900MM 3FT	 LowPro 15/10	 LowPro 15/10	 LowPro 23/05
1200MM 4FT	 LowPro 15/10	 LowPro 23/05	 LowPro 23/05





CODE COMPLIANCE

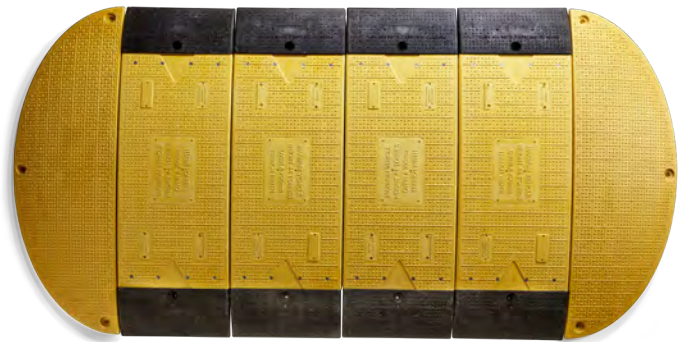
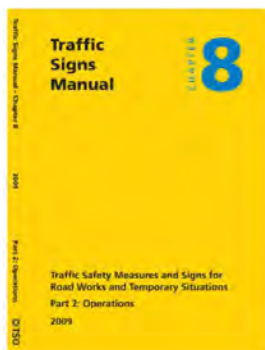

WHAT IS REGULATORY COMPLIANCE?

The Street Works manual, or red book tells contractors how to set up their street works site in a compliant manner. HAUC tell manufacturers how to make compliant products. Oxford Plastics design composite trench covers that are 100% compliant with HAUC 2018/01 advice note - SPECIFICATION AND OPERATIONAL REQUIREMENTS FOR FOOTWAY BOARDS, DRIVEWAY BOARDS, FOOTWAY RAMPS AND ROAD PLATES, Department for Transport - Safety At Street Works And Road Works – A Code Of Practice, Department for Transport TAL 6/14 - Using road plates at road works.

The LowPro 15/05 Road Plate is compliant with the above regulations for streetworks use.





HISTORY OF USE

Our composite Road Plates and Trench Covers have been used extensively:



METROPOLITAN USERS

- London
- New York
- Paris
- Munich
- Seoul
- Madrid
- San Francisco
- Tokyo
- Sydney



UTILITY USERS

- Gas
- Water
- Telecoms
- Electricity





COMPOSITE ROAD PLATE & TRENCH COVER SALES

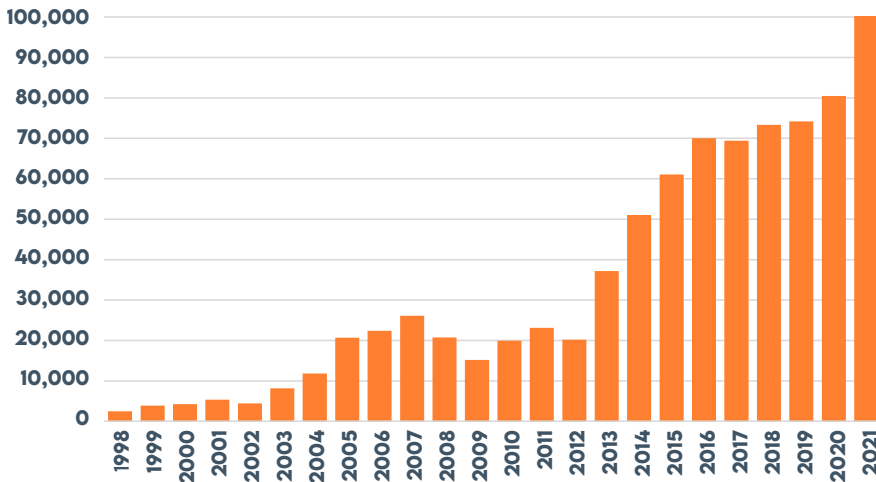

UNIT SALES

First concepts and products launched

1998

Worldwide sales since launch

+£54m

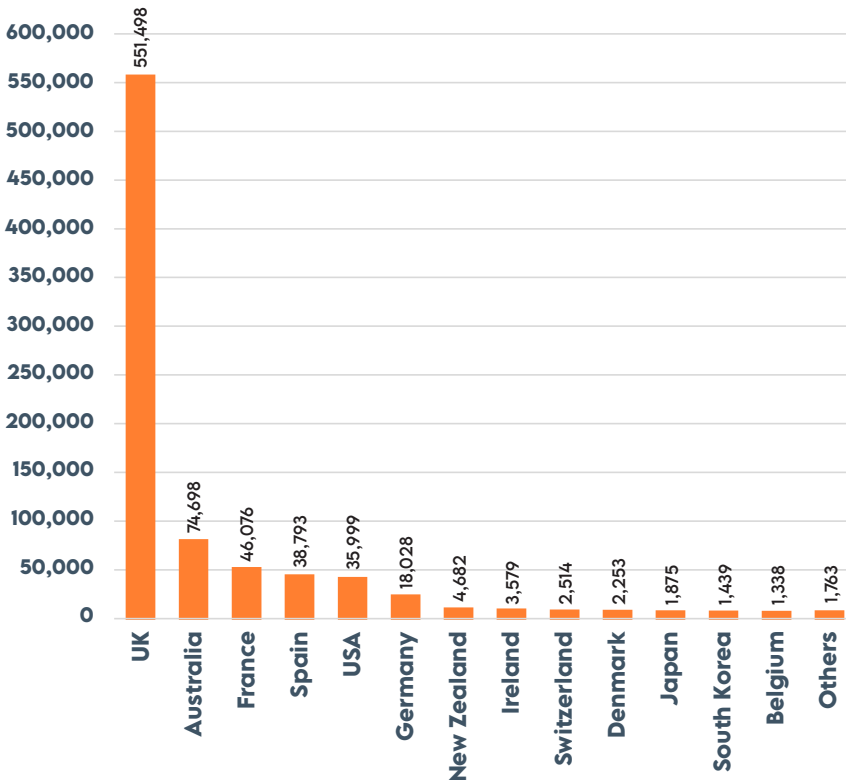

UNIT SALES BY COUNTRY

Countries using composite Road Plates and Trench Covers

42

Installations globally

+784k





CONTACT INFORMATION

UK & R.O.W

Oxford Plastic Systems Ltd
Unit T2, Enstone Business Park
Enstone,
Chipping Norton
Oxfordshire
OX7 4NP
United Kingdom

sales@oxfordplastics.com
Tel: +44(0)1608 678888

USA

Oxford Plastic Systems LLC
1011 Centre Rd,
Suite 312,
Wilmington
DE
19805
USA

info@oxfordplasticsusa.com
1-800-567-9182





APPENDIX A

**USA Engineering approval tabulated data.
See following pages.**



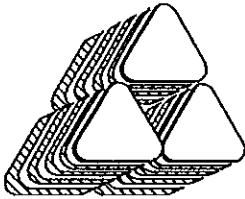

J.M. TURNER ENGINEERING, INC. CONSULTING ENGINEERS

CIVIL, STRUCTURAL, & CONSTRUCTION ENGINEERING

1325 College Avenue * Santa Rosa, CA 95404 * Phone (707) 528-4503 * Fax (707) 528-4505

E-MAIL TRANSMITTAL COVER SHEET

TO: David Sardinha
COMPANY: Oxford Plastics
PHONE: 401-497-0821
E-MAIL: david.sardinha@oxfordplastics
CC

FROM: Hans Vermeulen
DATE: 11/15/2013
PAGES: 05 including cover sheet
RE: 15/5 road plate

E-MAILED BY: _____ TIME: 12:00 pm

MESSAGE:

See attached tabulated data sheets for the 15/5 road plate.

Thank you for your business!

Hans

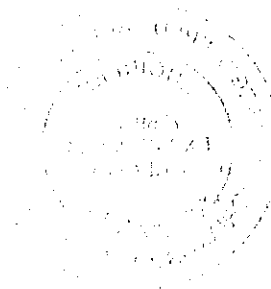

OXFORD PLASTICS USA.

MANUFACTURERS TABULATED DATA SHEET

15/5 OXFORD ROAD PLATE

BASED ON HS-20-44 LOADING

PLATE SIZE (FT)	MAX. SPEED (MPH)	MAX. ALLOW. SPAN (FT)	DESIGN IMPACT FACTOR
1'-8" x 4'-11" (0.5m x 1.5m)	< 30	2'-3"	1.3
1'-8" x 4'-11" (0.5m x 1.5m)	> 30 *	2'-3"	1.3

* ANCHORAGE REQUIRED

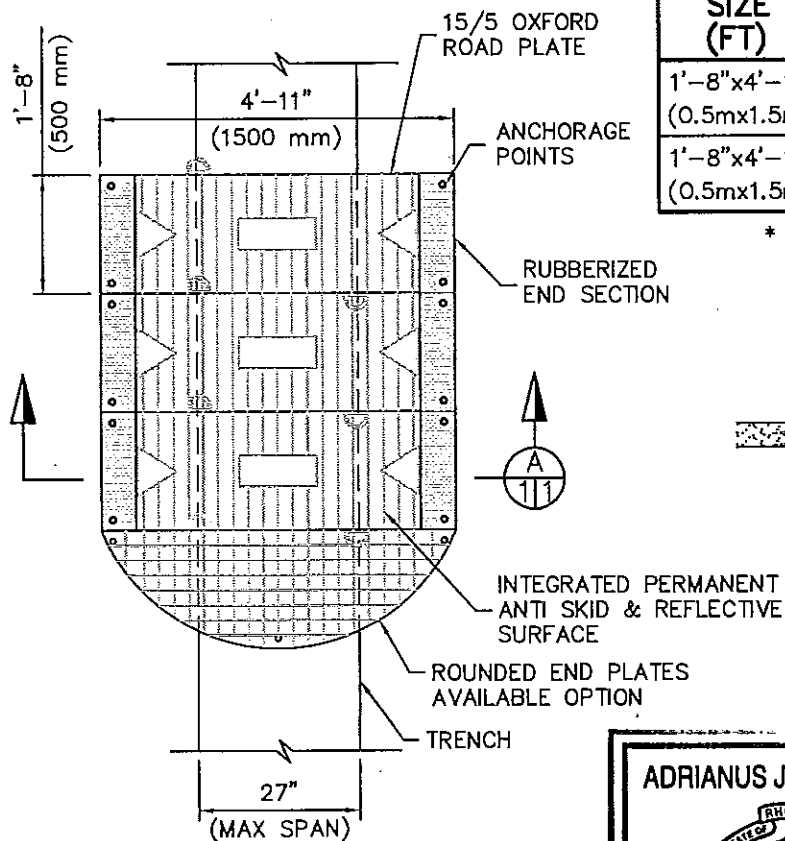

PLAN VIEW

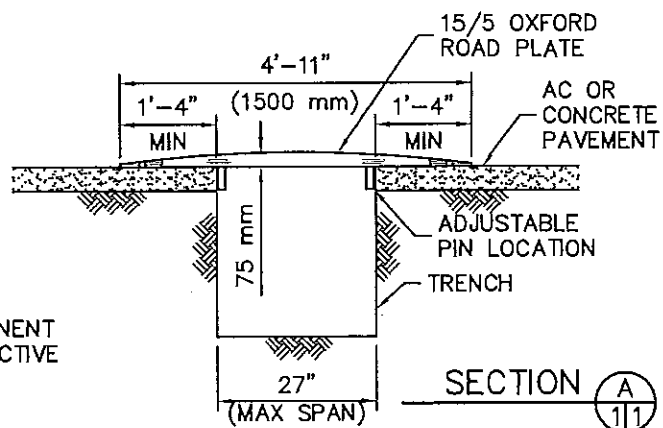

SECTION A

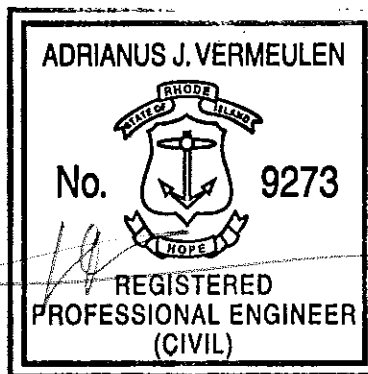

NOTES:

1. PLATE MATERIAL TO BE GLASS REINFORCED POLYESTER W/ STEEL REINFORCEMENT.
2. PLATES ARE DESIGNED FOR HS-20-44 LOADING = 32,000 lb AXLE, 16,000 lb TIRE LOAD WITH IMPACT FACTOR OF 1.3.
3. THE MAX SPAN IS MEASURED FROM ASPHALT OR CONCRETE EDGE TO ASPHALT OR CONCRETE EDGE.
4. CHART IS BASED ON STABLE TRENCH. STABILITY TO BE DETERMINED BY COMPETENT PERSON OR PROFESSIONAL ENGINEER. SHORING MAYBE REQUIRED.
5. IF SPEED EXCEEDS 30 mph, PLATE MAY REQUIRE ANCHORAGE.
6. SEE MANUFACTURES INFO FOR USE AND GUIDANCE.
7. THE INSTALLATION OF THE OXFORD ROAD PLATES MUST NOT PRESENT A HAZARD TO CYCLISTS OR MOTOR CYCLES.

TITLE:

15/5 OXFORD ROAD PLATE

OXFORD PLASTICS USA.

101 DEXTER ROAD
PROVIDENCE, RI. 02914

J.M. TURNER ENGINEERING, INC. CONSULTING ENGINEERS



1325 COLLEGE AVE, SANTA ROSA, CA 95404
(707) 528-4503 FAX (707) 528-4505

DATE:

11/13/13

REVISED:

FILE NO:

13741-1/P1

OXFORD PLASTICS USA.

MANUFACTURERS TABULATED DATA SHEET

15/5 OXFORD ROAD PLATE

ADDITIONAL LICENSES



Expires 6/30/2016

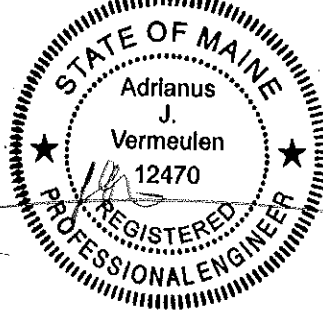
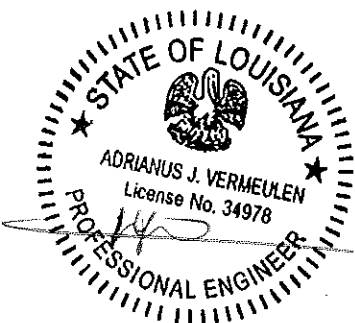
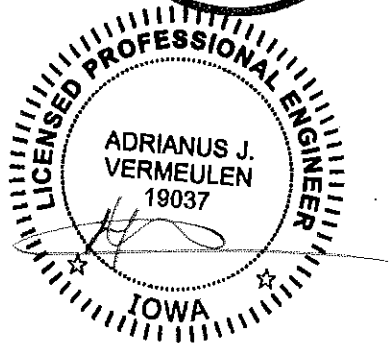
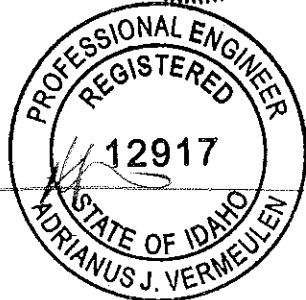
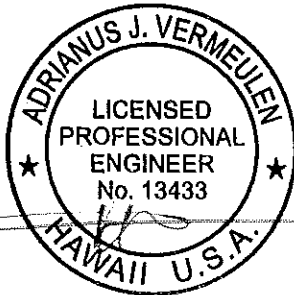
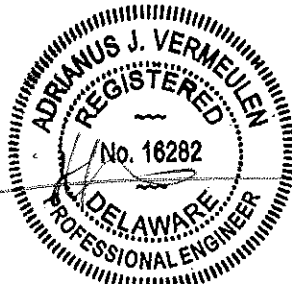
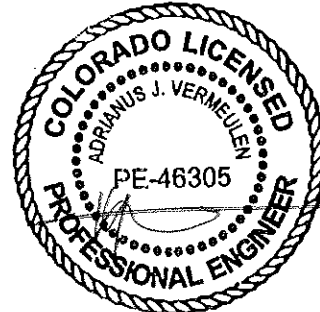

I hereby certify that this plan, specification, or report was prepared by me or under my direct supervision and that I am a duly Licensed Professional Engineer under the laws of the State of Minnesota.

Adrianus J. Vermeulen

Date 11/14/13 License # 48822

TITLE:

15/5 OXFORD ROAD PLATE

OXFORD PLASTICS USA.

101 DEXTER ROAD
PROVIDENCE, RI. 02914

J.M. TURNER ENGINEERING, INC.
CONSULTING ENGINEERS



1325 COLLEGE AVE, SANTA ROSA, CA 95404
(707) 528-4503 FAX (707) 528-4505

DATE:

11/13/13

REVISED:

FILE NO:

13741-1/P2

OXFORD PLASTICS USA.

MANUFACTURERS TABULATED DATA SHEET

15/5 OXFORD ROAD PLATE

ADDITIONAL LICENSES

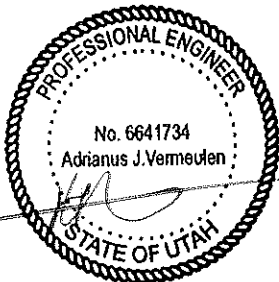
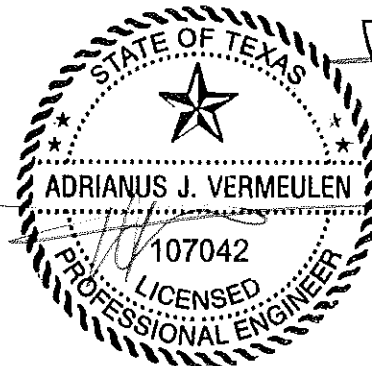
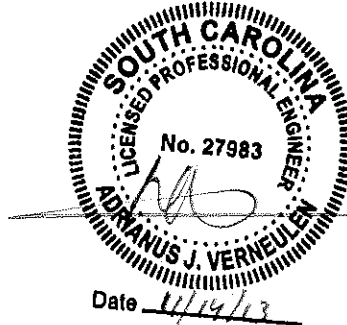
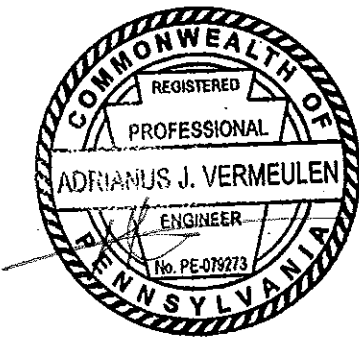
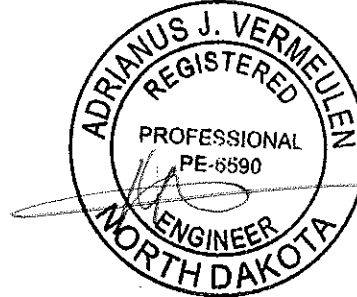
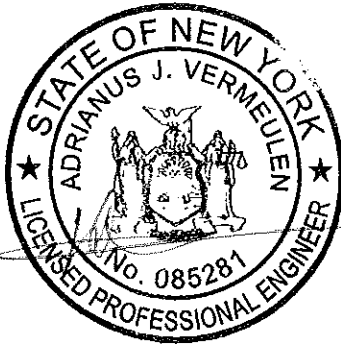
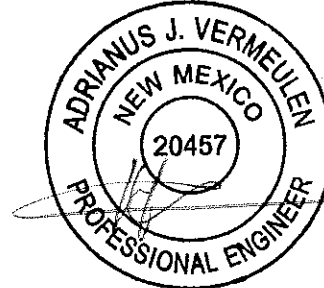
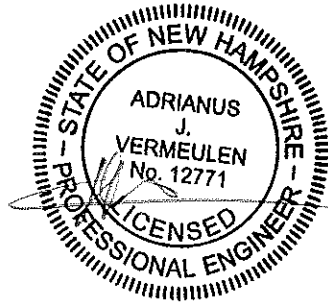

Dated: 11/14/13

EXPIRES 09-04-14

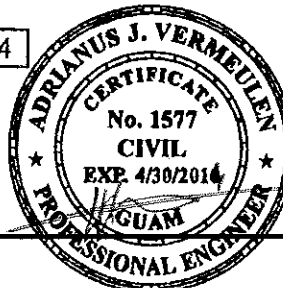

TITLE:

15/5 OXFORD ROAD PLATE

OXFORD PLASTICS USA.

101 DEXTER ROAD
PROVIDENCE, RI. 02914

J.M. TURNER ENGINEERING, INC.
CONSULTING ENGINEERS



1325 COLLEGE AVE, SANTA ROSA, CA 95404
(707) 528-4503 FAX (707) 528-4505

DATE:

11/13/13

REVISED:

FILE NO:

13741-1/P3

	HANS VERMEULEN	
STATE	LICENSE #	EXP DATE
ALABAMA		
ALASKA		
ARIZONA	46429	6/30/2016
ARKANSAS		
CALIFORNIA	69082	6/30/2014
COLORADO	PE-46305	10/31/2015
CONNECTICUT	26777	1/31/2014
DELAWARE	16282	6/30/2014
FLORIDA		
GEORGIA	PE035728	12/31/2014
HAWAII	13433	4/30/2014
IDAHO	12917	9/30/2014
ILLINOIS		
INDIANA		
IOWA	19037	12/31/2013
KANSAS		
KENTUCKY		
LOUISIANA	34978	3/31/2014
MAINE	12470	12/31/2013
MARYLAND		
MASSACHUSETTS	48320	6/30/2014
MICHIGAN		
MINNESOTA	48822	6/30/2014
MISSISSIPPI		
MISSOURI		
MONTANA		
NEBRASKA		
NEVADA	18990	6/30/2014
NEW HAMPSHIRE	12771	9/30/2014
NEW JERSEY		
NEW MEXICO	20457	12/31/2013
NEW YORK	085281-1	8/31/2016
NORTH CAROLINA	35531	12/31/2013
NORTH DAKOTA	PE-6590	12/31/2014
OHIO		
OKLAHOMA		
OREGON	79695PE	6/30/2014
PENNSYLVANIA	PE079273	9/30/2015
SOUTH CAROLINA	27983	6/30/2014
SOUTH DAKOTA		
TENNESSEE		
TEXAS	107042	9/30/2014
UTAH	6641734-2202	3/31/2015
VERMONT		
VIRGINIA		
WASHINGTON	43601	9/4/2014
WEST VIRGINIA		
WISCONSIN		
WYOMING		

GUAM	CE #1577	4/30/2014
ALBERTA, CANADA		
BRITISH COLUMBIA		