



# LOWPRO 100 NARROW TRENCH COVER





# CONTENTS

PAGE	
3	<b>Features and benefits</b>
4	<b>What problems does it solve?</b>
5	<b>Dimensions and weights</b>
6	<b>Slip resistance</b>
7	<b>Safety</b>
8	<b>Installation</b>
9	<b>Recyclability</b>
10	<b>Inspection and maintenance</b>
11	<b>Associated products</b>
12	<b>Trench cover guide</b>
13	<b>Code compliance</b>
14	<b>Contact information</b>





## FEATURES AND BENEFITS

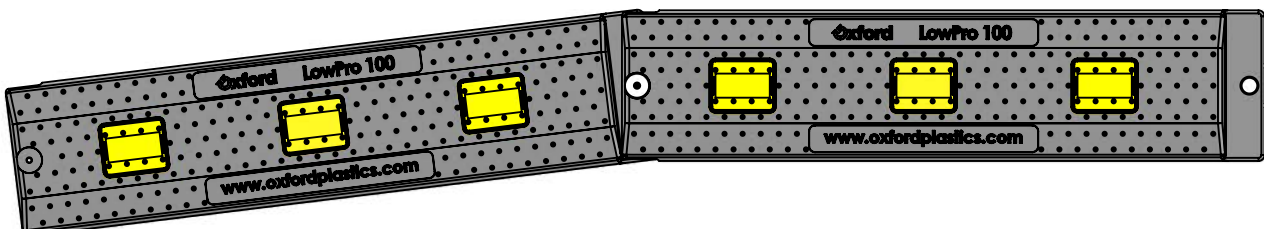
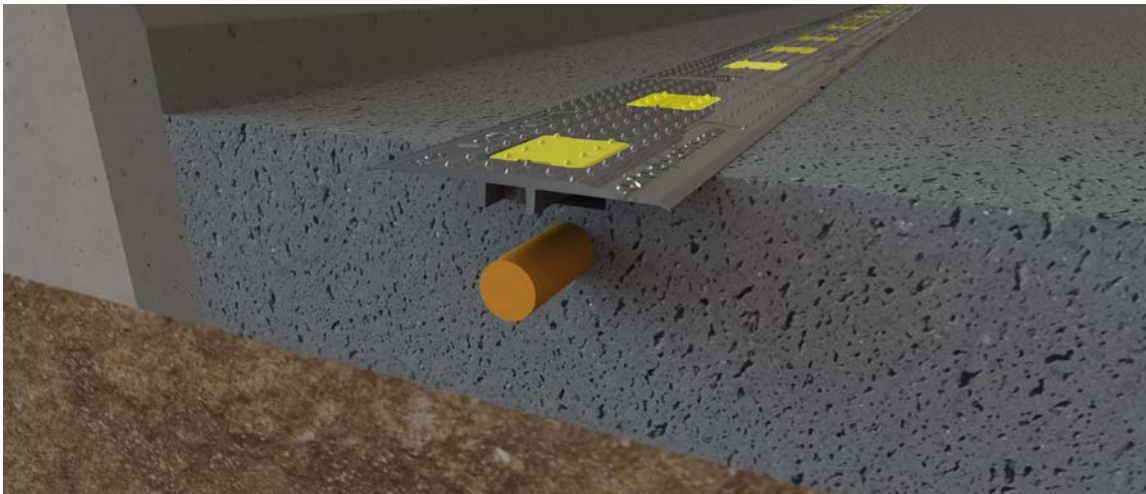

### APPLICATIONS

Narrow trench cover: 75mm / 3" to 100mm / 3.9" wide trenches

Fibre optic cable installation & maintenance

Water service pipe installation & maintenance

For straight line excavations or curved excavations

### SAFETY

Slots securely into the trench

Hi-vis inserts for visibility day or night

Highly slip resistant

Suitable for pedestrian traffic and vehicles

### USAGE

LowPro 100s slot together using the pin and bucket connectors moulded into the product

Available in 20mm / 0.8" and 40mm / 1.6" depths

Made of recycled plastic

Can be recycled at end of life





## WHAT PROBLEMS DOES IT SOLVE?

Before the LowPro 100, workers would either:

Use large trench covers

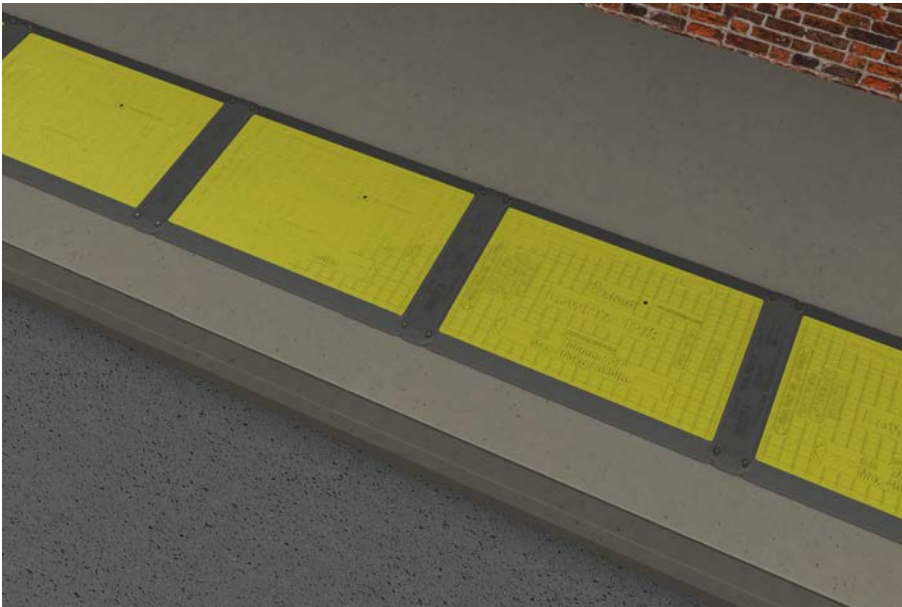

### The LowPro 100

Takes up less space in transport and storage

Is more cost effective

Barrier the excavated area

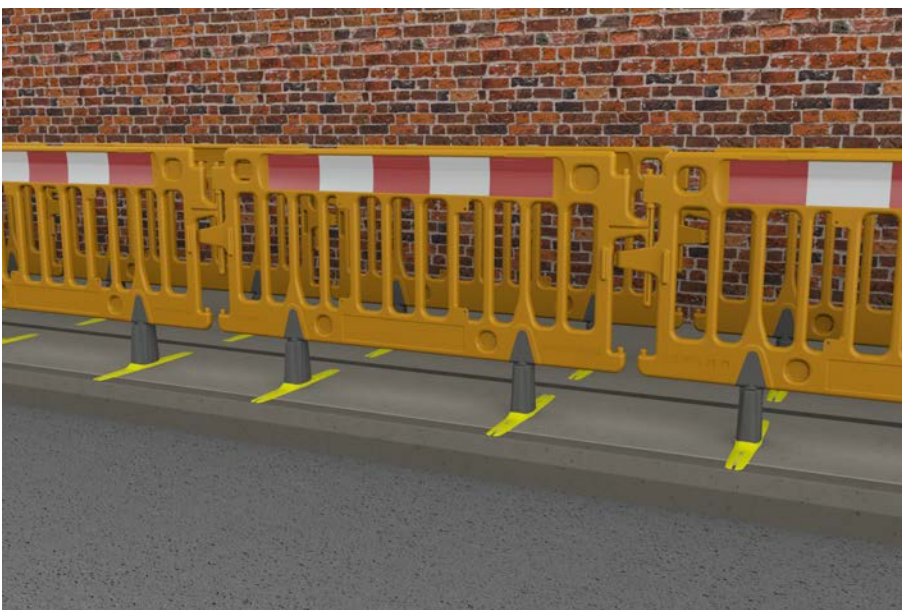

### The LowPro 100

Allows access on road and pavements

Is more cost effective





# DIMENSIONS AND WEIGHTS

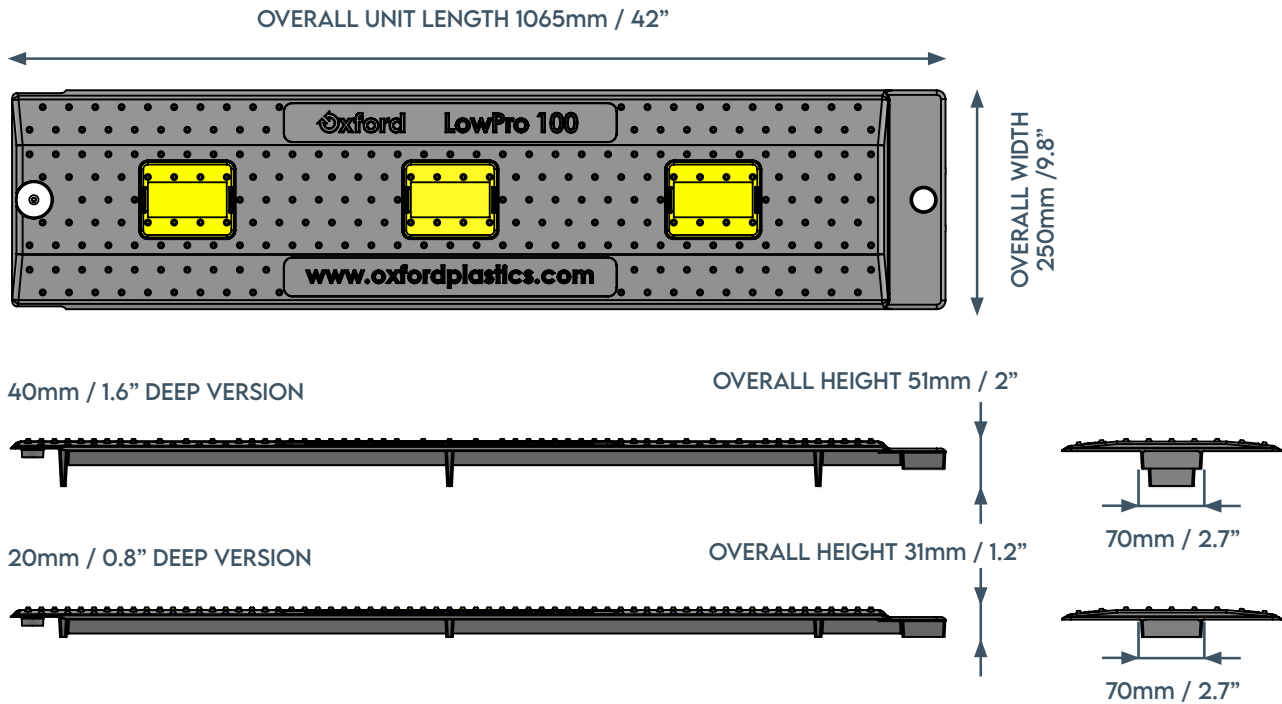

Part Name	LowPro 100® Narrow Trench Cover 40mm / 1.6"	LowPro 100® Narrow Trench Cover 20mm / 0.8"
Product code:	O761	O762
Height:	51mm / 2"	31mm / 1.2"
Width:	250mm / 9.8"	250mm / 9.8"
Length:	1065mm / 42"	1065mm / 42"
Weight:	3.23kg / 7.1lb	3.2kg / 7lb
QTY per pallet:	100 1m / 39.4" sections	100 1m / 39.4" sections

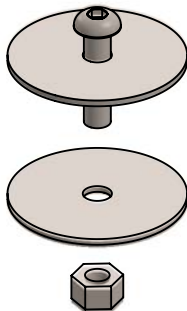

## RECOMMENDED FIXINGS

Two 1m sections can be connected together using the following fixings. In most short-term applications, 2m LowPro 100 does not need to be connected any further. For long-term applications, 2m LowPro 100 can also be bolted together using the same recommended fixings::

M6 x 25mm long button head screw x1

M6 Nyloc locknut x 1

M6 Penny washer Ø40mm x 2





# SLIP RESISTANCE

Slip resistance testing has been carried out by an independent test house, using standard HSE techniques in accordance with BS 7976-2:2002+A1:2013, and the UK Slip Resistance Guidelines (UKSRG) – Issue 5:2016, where appropriate. Testing was carried out in 4 directions in wet and dry conditions, using a calibrated slip tester using Slider 55 and Slider 96.

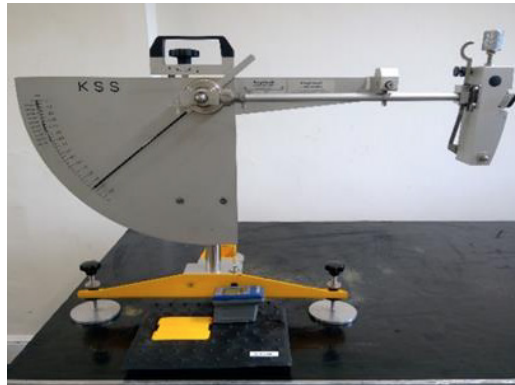

## CLASSIFICATIONS

High Slip Potential  
0-24

Moderate Slip Potential  
25-35

Low Slip Potential  
36+

### SLIDER 96 TEST RESULTS - DRY

	Median Result	Classification
Parallel to traffic	75	LOW SLIP POTENTIAL
Perpendicular to traffic	82	LOW SLIP POTENTIAL
45 degrees to traffic	89	LOW SLIP POTENTIAL
10 degrees to traffic	77	LOW SLIP POTENTIAL

### SLIDER 96 TEST RESULTS - WET

Parallel to traffic	68	LOW SLIP POTENTIAL
Perpendicular to traffic	66	LOW SLIP POTENTIAL
45 degrees to traffic	59	LOW SLIP POTENTIAL
10 degrees to traffic	62	LOW SLIP POTENTIAL

### SLIDER 55 TEST RESULTS - DRY

Parallel to traffic	93	LOW SLIP POTENTIAL
Perpendicular to traffic	116	LOW SLIP POTENTIAL
45 degrees to traffic	105	LOW SLIP POTENTIAL
10 degrees to traffic	99	LOW SLIP POTENTIAL

### SLIDER 55 TEST RESULTS - WET

Parallel to traffic	52	LOW SLIP POTENTIAL
Perpendicular to traffic	54	LOW SLIP POTENTIAL
45 degrees to traffic	41	LOW SLIP POTENTIAL
10 degrees to traffic	38	LOW SLIP POTENTIAL



# SAFETY

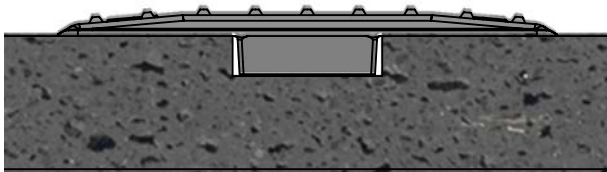

20mm DEEP VERSION

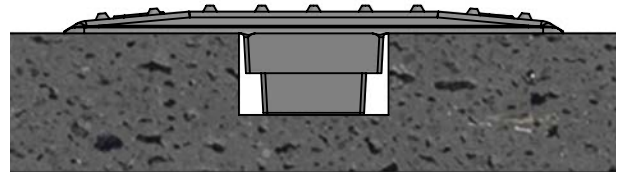

40mm DEEP VERSION

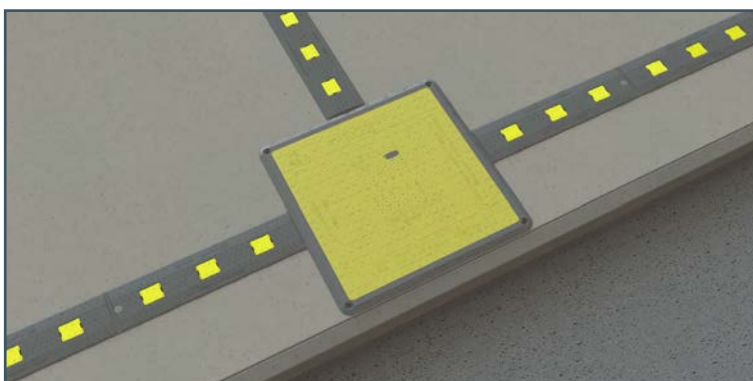

The LowPro 100 is suitable for pedestrians and vehicles and can be used on any trench depth. The recycled material is very tough, so it won't break even with extreme loads.

- Supports the load of any road vehicle. The narrow trench is much slimmer than the width of a tyre, and so the load is distributed and supported by the sides of the trench.
- Suitable for use in any trench depth: 20mm to 1000mm
- Slots securely into the trench
- Hi-vis inserts for visibility day or night
- Highly slip resistant

At a T junction, where the trench is directed into a residence, a LowPro 11/11 can be placed over the junction area.

The LowPro 11/11 is a pedestrian board not for roadway use, that can take the weight of a 1.6t vehicle over a 700mm span.





## INSTALLATION

Follow the process below for safe and effective installations.

Risk assessments should be carried out to ensure the usage is suitable for the scenario.



For use on 75mm / 3" to 100mm / 3.9" trenches on pavements and driveways.

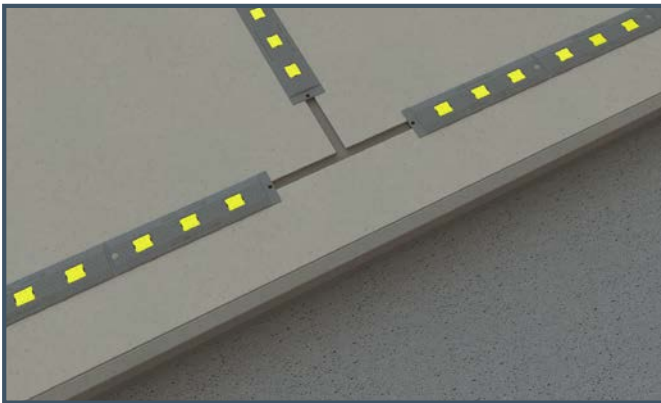

Slot the LowPro 100 into the trench.

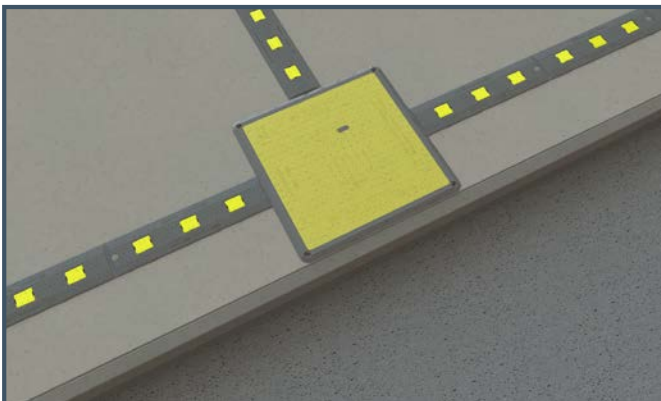

At a T junction, where the trench is directed into a residence, place a LowPro 11/11 over the junction area.







# RECYCLABILITY

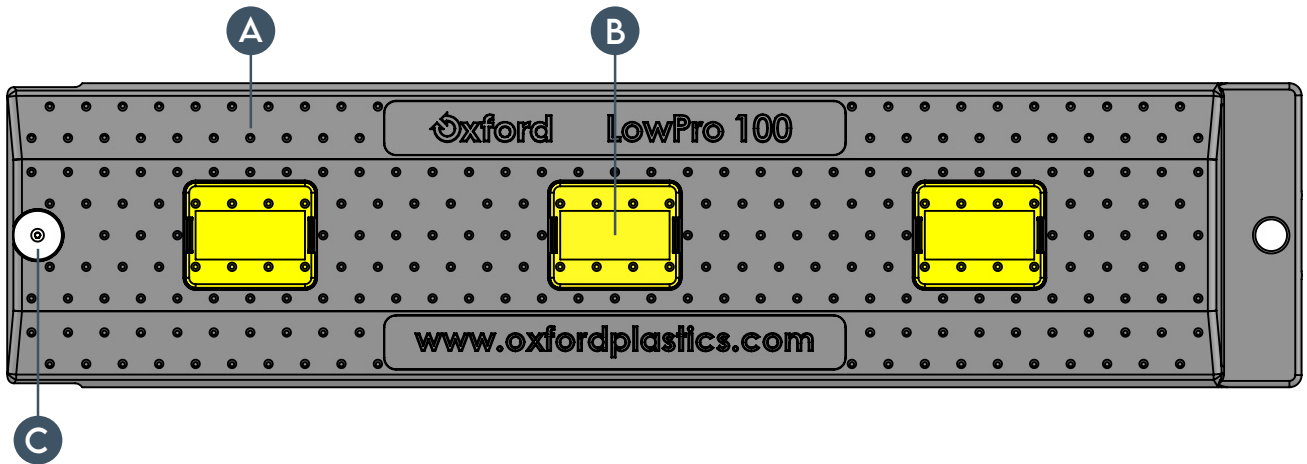

## MADE OF RECYCLED MATERIAL

	Part name	Material	Product code
A	LowPro 100	Recycled plastic	O761 / O762
B	Hi-vis inserts	HDPE	O763
C	Washers, bolt & nut	Steel	



### CLOSED LOOP RECYCLING

End of life products can be returned to Oxford Plastics for recycling.

### RIGHT TO REPAIR

LowPro 100 is a modular system. The hi-vis inserts and fixings are available for replacement.





# INSPECTION AND MAINTENANCE

Care for the product by following the below guidance:

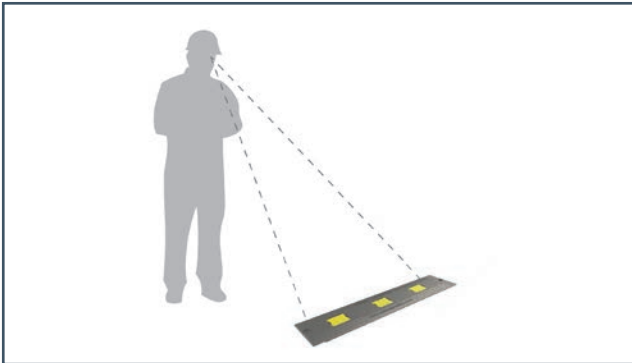

Inspect each product for signs of damage, between every installation.



Clean product between every installation to remove debris, and to maintain slip resistance properties.

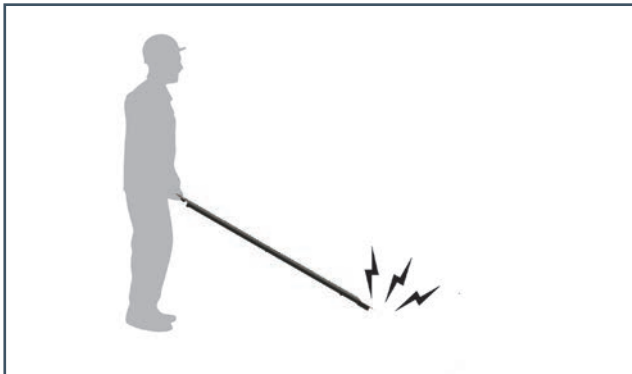

Do not drop the product.  
Do not lift or move with machinery.

## SIGNS OF DAMAGE

Cracks in black section indicate it has been damaged through improper use.

The product should lay flat on the ground. Damaged products should be recycled



Stack the LowPro 100 into a pallet for storage.





# ASSOCIATED PRODUCTS

When setting up a street works site, other Oxford Plastics solutions can be used to ensure compliance is achieved. Browse our Chapter 8 solutions; including advanced barrier systems, trench covers, road plates, wheelchair ramps and street works signs.



**ADVANCED BARRIER SYSTEMS**



**PORTABLE GATE BARRIERS**



**STREET WORKS SIGNS**



**WHEELCHAIR RAMP**



**TRENCH COVERS**



**ROAD PLATES**

















# TRENCH COVER GUIDE

## COMPOSITE TRENCH COVERS CAN BE INSTALLED IN THE FOLLOWING SCENARIOS.

- ▶ A Site Safety Risk Assessment must be carried out before installation, only install on compacted surfaces such as concrete or asphalt. Always place the trench cover centrally over the excavation.
- ▶ In some instances, road plates and trench covers must be bolted for safety, refer to the installation guide for more details.
- ▶ Trench covers have a maximum width allowance.
- ▶ Trench covers can be linked together to safely cover any length of excavation.
- ▶ The LowPro range is HAUC Compliant.
- ▶ LowPro 15/05 and LowPro 23/05 are HS20-44 load rated.
- ▶ Trench covers must be installed centrally over the trench.

MAXIMUM TRENCH WIDTH	WHAT TYPE OF TRAFFIC WILL CROSS THE TRENCH?		
	FOOTWAY 400KG / 880LBS	DRIVEWAY 3.5T / 7715LBS VEHICLE	ROADWAY 44T / 97000LBS VEHICLE
100MM 4"	 LowPro 100	 LowPro 100	 LowPro 15/05
700MM 2FT	 LowPro 12/8  LowPro 11/11	 LowPro 15/10	 LowPro 15/05
900MM 3FT	 LowPro 15/10	 LowPro 15/10	 LowPro 23/05
1200MM 4FT	 LowPro 15/10	 LowPro 23/05	 LowPro 23/05





## CODE COMPLIANCE

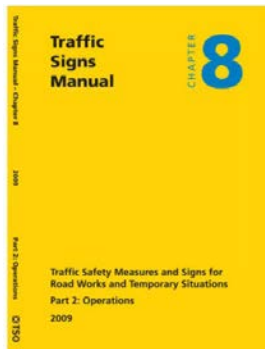
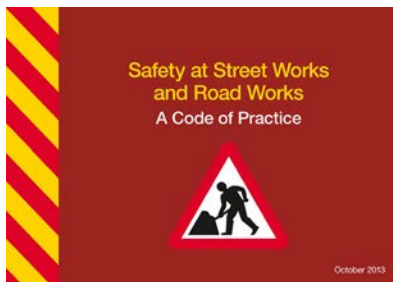

### WHAT IS REGULATORY COMPLIANCE?

The Street Works manual, or red book tells contractors how to set up their street works site in a compliant manner. HAUC tell manufactures how to make compliant products. Oxford Plastics design composite trench covers that are 100% compliant with HAUC 2018/01 advice note - SPECIFICATION AND OPERATIONAL REQUIREMENTS FOR FOOTWAY BOARDS, DRIVEWAY BOARDS, FOOTWAY RAMPS AND ROAD PLATES, Department for Transport - Safety At Street Works And Road Works – A Code Of Practice, Department for Transport TAL 6/14 - Using road plates at road works.

The LowPro 100 Narrow Trench Cover is compliant with the above regulations for streetworks use.





## CONTACT INFORMATION

### UK & R.O.W

Oxford Plastic Systems Ltd  
Unit T2, Enstone Business Park  
Enstone,  
Chipping Norton  
Oxfordshire  
OX7 4NP  
United Kingdom

[sales@oxfordplastics.com](mailto:sales@oxfordplastics.com)  
Tel: +44(0)1608 678888

### USA

Oxford Plastic Systems LLC  
1011 Centre Rd,  
Suite 312,  
Wilmington  
DE  
19805  
USA

[info@oxfordplasticsusa.com](mailto:info@oxfordplasticsusa.com)  
1-800-567-9182

